

Řemeny

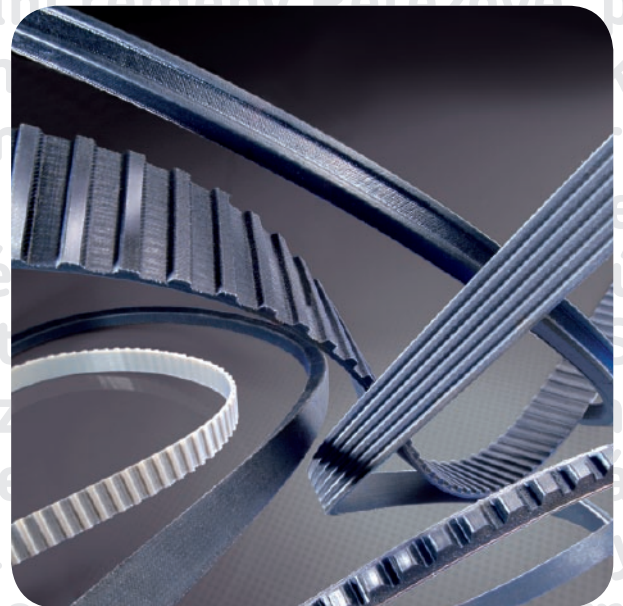



Klínové řemeny obalované s úzkým průřezem

SPZ

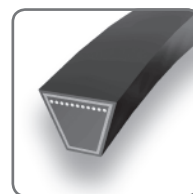

Oddíl SPZ

Typ řemenu	Roztečná délka mm	Označení	Typ řemenu	Roztečná délka mm	Označení
SPZ512	512	PHG SPZ512	SPZ1347	1347	PHG SPZ1347
SPZ560	560	PHG SPZ560	SPZ1362	1362	PHG SPZ1362
SPZ562	562	PHG SPZ562	SPZ1387	1387	PHG SPZ1387
SPZ587	587	PHG SPZ587	SPZ1400	1400	PHG SPZ1400
SPZ612	612	PHG SPZ612	SPZ1412	1412	PHG SPZ1412
SPZ630	630	PHG SPZ630	SPZ1420	1420	PHG SPZ1420
SPZ637	637	PHG SPZ637	SPZ1437	1437	PHG SPZ1437
SPZ662	662	PHG SPZ662	SPZ1462	1462	PHG SPZ1462
SPZ670	670	PHG SPZ670	SPZ1487	1487	PHG SPZ1487
SPZ687	687	PHG SPZ687	SPZ1500	1500	PHG SPZ1500
SPZ710	710	PHG SPZ710	SPZ1512	1512	PHG SPZ1512
SPZ722	722	PHG SPZ722	SPZ1520	1520	PHG SPZ1520
SPZ737	737	PHG SPZ737	SPZ1537	1537	PHG SPZ1537
SPZ750	750	PHG SPZ750	SPZ1562	1562	PHG SPZ1562
SPZ760	760	PHG SPZ760	SPZ1587	1587	PHG SPZ1587
SPZ762	762	PHG SPZ762	SPZ1600	1600	PHG SPZ1600
SPZ772	772	PHG SPZ772	SPZ1612	1612	PHG SPZ1612
SPZ787	787	PHG SPZ787	SPZ1637	1637	PHG SPZ1637
SPZ800	800	PHG SPZ800	SPZ1650	1650	PHG SPZ1650
SPZ812	812	PHG SPZ812	SPZ1662	1662	PHG SPZ1662
SPZ825	825	PHG SPZ825	SPZ1687	1687	PHG SPZ1687
SPZ837	837	PHG SPZ837	SPZ1700	1700	PHG SPZ1700
SPZ850	850	PHG SPZ850	SPZ1737	1737	PHG SPZ1737
SPZ862	862	PHG SPZ862	SPZ1750	1750	PHG SPZ1750
SPZ875	875	PHG SPZ875	SPZ1762	1762	PHG SPZ1762
SPZ887	887	PHG SPZ887	SPZ1787	1787	PHG SPZ1787
SPZ900	900	PHG SPZ900	SPZ1800	1800	PHG SPZ1800
SPZ912	912	PHG SPZ912	SPZ1812	1812	PHG SPZ1812
SPZ925	925	PHG SPZ925	SPZ1837	1837	PHG SPZ1837
SPZ937	937	PHG SPZ937	SPZ1850	1850	PHG SPZ1850
SPZ950	950	PHG SPZ950	SPZ1862	1862	PHG SPZ1862
SPZ962	962	PHG SPZ962	SPZ1887	1887	PHG SPZ1887
SPZ987	987	PHG SPZ987	SPZ1900	1900	PHG SPZ1900
SPZ1000	1000	PHG SPZ1000	SPZ1937	1937	PHG SPZ1937
SPZ1010	1010	PHG SPZ1010	SPZ1950	1950	PHG SPZ1950
SPZ1012	1012	PHG SPZ1012	SPZ1987	1987	PHG SPZ1987
SPZ1024	1024	PHG SPZ1024	SPZ2000	2000	PHG SPZ2000
SPZ1037	1037	PHG SPZ1037	SPZ2037	2037	PHG SPZ2037
SPZ1047	1047	PHG SPZ1047	SPZ2060	2060	PHG SPZ2060
SPZ1060	1060	PHG SPZ1060	SPZ2120	2120	PHG SPZ2120
SPZ1077	1077	PHG SPZ1077	SPZ2137	2137	PHG SPZ2137
SPZ1080	1080	PHG SPZ1080	SPZ2160	2160	PHG SPZ2160
SPZ1087	1087	PHG SPZ1087	SPZ2187	2187	PHG SPZ2187
SPZ1112	1112	PHG SPZ1112	SPZ2240	2240	PHG SPZ2240
SPZ1120	1120	PHG SPZ1120	SPZ2262	2262	PHG SPZ2262
SPZ1137	1137	PHG SPZ1137	SPZ2280	2280	PHG SPZ2280
SPZ1140	1140	PHG SPZ1140	SPZ2287	2287	PHG SPZ2287
SPZ1150	1150	PHG SPZ1150	SPZ2360	2360	PHG SPZ2360
SPZ1162	1162	PHG SPZ1162	SPZ2410	2410	PHG SPZ2410
SPZ1180	1180	PHG SPZ1180	SPZ2500	2500	PHG SPZ2500
SPZ1187	1187	PHG SPZ1187	SPZ2540	2540	PHG SPZ2540
SPZ1200	1200	PHG SPZ1200	SPZ2580	2580	PHG SPZ2580
SPZ1202	1202	PHG SPZ1202	SPZ2650	2650	PHG SPZ2650
SPZ1212	1212	PHG SPZ1212	SPZ2690	2690	PHG SPZ2690
SPZ1237	1237	PHG SPZ1237	SPZ2800	2800	PHG SPZ2800
SPZ1250	1250	PHG SPZ1250	SPZ2840	2840	PHG SPZ2840
SPZ1262	1262	PHG SPZ1262	SPZ2900	2900	PHG SPZ2900
SPZ1270	1270	PHG SPZ1270	SPZ3000	3000	PHG SPZ3000
SPZ1287	1287	PHG SPZ1287	SPZ3150	3150	PHG SPZ3150
SPZ1312	1312	PHG SPZ1312	SPZ3170	3170	PHG SPZ3170
SPZ1320	1320	PHG SPZ1320	SPZ3350	3350	PHG SPZ3350
SPZ1337	1337	PHG SPZ1337	SPZ3550	3550	PHG SPZ3550
SPZ1340	1340	PHG SPZ1340	-	-	-

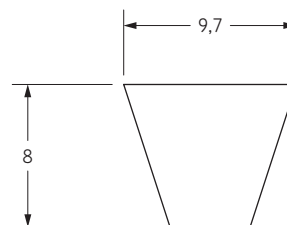

Nabídka obsahuje rovněž nestandardní délky.

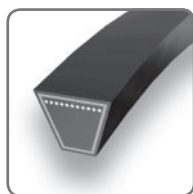

Klínové řemeny obalované s úzkým průřezem

SPA

- ▶ Řemeny
- ▶ Řetězy
- ▶ Spojky
- ▶ Pouzdra a náboje
- ▶ Řetězová kola
- ▶ Řemenice
- ▶ Inteligentní nástroje

Oddíl SPA

Typ řemenu	Roztečná délka	Označení	Typ řemenu	Roztečná délka	Označení
	mm			mm	
SPA732	732	PHG SPA732	SPA1682	1682	PHG SPA1682
SPA757	757	PHG SPA757	SPA1700	1700	PHG SPA1700
SPA775	775	PHG SPA775	SPA1707	1707	PHG SPA1707
SPA782	782	PHG SPA782	SPA1732	1732	PHG SPA1732
SPA800	800	PHG SPA800	SPA1750	1750	PHG SPA1750
SPA807	807	PHG SPA807	SPA1757	1757	PHG SPA1757
SPA832	832	PHG SPA832	SPA1782	1782	PHG SPA1782
SPA850	850	PHG SPA850	SPA1800	1800	PHG SPA1800
SPA857	857	PHG SPA857	SPA1807	1807	PHG SPA1807
SPA882	882	PHG SPA882	SPA1820	1820	PHG SPA1820
SPA900	900	PHG SPA900	SPA1832	1832	PHG SPA1832
SPA907	907	PHG SPA907	SPA1850	1850	PHG SPA1850
SPA925	925	PHG SPA925	SPA1857	1857	PHG SPA1857
SPA932	932	PHG SPA932	SPA1882	1882	PHG SPA1882
SPA950	950	PHG SPA950	SPA1900	1900	PHG SPA1900
SPA957	957	PHG SPA957	SPA1907	1907	PHG SPA1907
SPA969	969	PHG SPA969	SPA1932	1932	PHG SPA1932
SPA975	975	PHG SPA975	SPA1950	1950	PHG SPA1950
SPA982	982	PHG SPA982	SPA1957	1957	PHG SPA1957
SPA1000	1000	PHG SPA1000	SPA1982	1982	PHG SPA1982
SPA1007	1007	PHG SPA1007	SPA2000	2000	PHG SPA2000
SPA1030	1030	PHG SPA1030	SPA2032	2032	PHG SPA2032
SPA1032	1032	PHG SPA1032	SPA2057	2057	PHG SPA2057
SPA1055	1055	PHG SPA1055	SPA2060	2060	PHG SPA2060
SPA1060	1060	PHG SPA1060	SPA2082	2082	PHG SPA2082
SPA1082	1082	PHG SPA1082	SPA2120	2120	PHG SPA2120
SPA1090	1090	PHG SPA1090	SPA2132	2132	PHG SPA2132
SPA1107	1107	PHG SPA1107	SPA2160	2160	PHG SPA2160
SPA1120	1120	PHG SPA1120	SPA2182	2182	PHG SPA2182
SPA1132	1132	PHG SPA1132	SPA2207	2207	PHG SPA2207
SPA1150	1150	PHG SPA1150	SPA2232	2232	PHG SPA2232
SPA1157	1157	PHG SPA1157	SPA2240	2240	PHG SPA2240
SPA1180	1180	PHG SPA1180	SPA2282	2282	PHG SPA2282
SPA1190	1190	PHG SPA1190	SPA2300	2300	PHG SPA2300
SPA1200	1200	PHG SPA1200	SPA2307	2307	PHG SPA2307
SPA1207	1207	PHG SPA1207	SPA2332	2332	PHG SPA2332
SPA1220	1220	PHG SPA1220	SPA2360	2360	PHG SPA2360
SPA1232	1232	PHG SPA1232	SPA2382	2382	PHG SPA2382
SPA1250	1250	PHG SPA1250	SPA2430	2430	PHG SPA2430
SPA1257	1257	PHG SPA1257	SPA2432	2432	PHG SPA2432
SPA1272	1272	PHG SPA1272	SPA2482	2482	PHG SPA2482
SPA1282	1282	PHG SPA1282	SPA2500	2500	PHG SPA2500
SPA1300	1300	PHG SPA1300	SPA2532	2532	PHG SPA2532
SPA1307	1307	PHG SPA1307	SPA2582	2582	PHG SPA2582
SPA1320	1320	PHG SPA1320	SPA2607	2607	PHG SPA2607
SPA1332	1332	PHG SPA1332	SPA2632	2632	PHG SPA2632
SPA1357	1357	PHG SPA1357	SPA2650	2650	PHG SPA2650
SPA1360	1360	PHG SPA1360	SPA2682	2682	PHG SPA2682
SPA1367	1367	PHG SPA1367	SPA2732	2732	PHG SPA2732
SPA1382	1382	PHG SPA1382	SPA2782	2782	PHG SPA2782
SPA1400	1400	PHG SPA1400	SPA2800	2800	PHG SPA2800
SPA1407	1407	PHG SPA1407	SPA2832	2832	PHG SPA2832
SPA1415	1415	PHG SPA1415	SPA2847	2847	PHG SPA2847
SPA1420	1420	PHG SPA1420	SPA2882	2882	PHG SPA2882
SPA1432	1432	PHG SPA1432	SPA2900	2900	PHG SPA2900
SPA1450	1450	PHG SPA1450	SPA2932	2932	PHG SPA2932
SPA1457	1457	PHG SPA1457	SPA2982	2982	PHG SPA2982
SPA1482	1482	PHG SPA1482	SPA3000	3000	PHG SPA3000
SPA1490	1490	PHG SPA1490	SPA3032	3032	PHG SPA3032
SPA1500	1500	PHG SPA1500	SPA3082	3082	PHG SPA3082
SPA1507	1507	PHG SPA1507	SPA3150	3150	PHG SPA3150
SPA1532	1532	PHG SPA1532	SPA3182	3182	PHG SPA3182
SPA1550	1550	PHG SPA1550	SPA3282	3282	PHG SPA3282
SPA1557	1557	PHG SPA1557	SPA3350	3350	PHG SPA3350
SPA1582	1582	PHG SPA1582	SPA3382	3382	PHG SPA3382
SPA1600	1600	PHG SPA1600	SPA3550	3550	PHG SPA3550
SPA1607	1607	PHG SPA1607	SPA3750	3750	PHG SPA3750
SPA1632	1632	PHG SPA1632	SPA4000	4000	PHG SPA4000
SPA1650	1650	PHG SPA1650	SPA4250	4250	PHG SPA4250
SPA1657	1657	PHG SPA1657	SPA4500	4500	PHG SPA4500

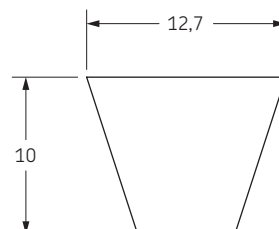

Nabídka obsahuje rovněž nestandardní délky.



Klínové řemeny obalované s úzkým průřezem

SPB

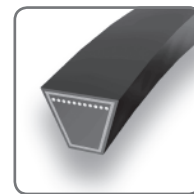

Oddíl SPB

Typ řemenu	Roztečná délka mm	Označení	Typ řemenu	Roztečná délka mm	Označení
SPB1250	1250	PHG SPB1250	SPB2800	2800	PHG SPB2800
SPB1260	1260	PHG SPB1260	SPB2840	2840	PHG SPB2840
SPB1270	1270	PHG SPB1270	SPB2900	2900	PHG SPB2900
SPB1280	1280	PHG SPB1280	SPB2990	2990	PHG SPB2990
SPB1320	1320	PHG SPB1320	SPB3000	3000	PHG SPB3000
SPB1340	1340	PHG SPB1340	SPB3070	3070	PHG SPB3070
SPB1400	1400	PHG SPB1400	SPB3150	3150	PHG SPB3150
SPB1410	1410	PHG SPB1410	SPB3250	3250	PHG SPB3250
SPB1450	1450	PHG SPB1450	SPB3350	3350	PHG SPB3350
SPB1465	1465	PHG SPB1465	SPB3450	3450	PHG SPB3450
SPB1500	1500	PHG SPB1500	SPB3550	3550	PHG SPB3550
SPB1510	1510	PHG SPB1510	SPB3650	3650	PHG SPB3650
SPB1525	1525	PHG SPB1525	SPB3750	3750	PHG SPB3750
SPB1590	1590	PHG SPB1590	SPB3750	3750	PHG SPB3750
SPB1600	1600	PHG SPB1600	SPB3800	3800	PHG SPB3800
SPB1650	1650	PHG SPB1650	SPB3870	3870	PHG SPB3870
SPB1690	1690	PHG SPB1690	SPB4000	4000	PHG SPB4000
SPB1700	1700	PHG SPB1700	SPB4060	4060	PHG SPB4060
SPB1720	1720	PHG SPB1720	SPB4120	4120	PHG SPB4120
SPB1750	1750	PHG SPB1750	SPB4250	4250	PHG SPB4250
SPB1800	1800	PHG SPB1800	SPB4310	4310	PHG SPB4310
SPB1850	1850	PHG SPB1850	SPB4500	4500	PHG SPB4500
SPB1900	1900	PHG SPB1900	SPB4560	4560	PHG SPB4560
SPB2000	2000	PHG SPB2000	SPB4620	4620	PHG SPB4620
SPB2020	2020	PHG SPB2020	SPB4750	4750	PHG SPB4750
SPB2060	2060	PHG SPB2060	SPB4820	4820	PHG SPB4820
SPB2120	2120	PHG SPB2120	SPB5000	5000	PHG SPB5000
SPB2150	2150	PHG SPB2150	SPB5070	5070	PHG SPB5070
SPB2180	2180	PHG SPB2180	SPB5300	5300	PHG SPB5300
SPB2240	2240	PHG SPB2240	SPB5380	5380	PHG SPB5380
SPB2280	2280	PHG SPB2280	SPB5500	5500	PHG SPB5500
SPB2360	2360	PHG SPB2360	SPB5600	5600	PHG SPB5600
SPB2410	2410	PHG SPB2410	SPB5680	5680	PHG SPB5680
SPB2430	2430	PHG SPB2430	SPB6000	6000	PHG SPB6000
SPB2500	2500	PHG SPB2500	SPB6300	6300	PHG SPB6300
SPB2530	2530	PHG SPB2530	SPB6340	6340	PHG SPB6340
SPB2580	2580	PHG SPB2580	SPB6700	6700	PHG SPB6700
SPB2600	2600	PHG SPB2600	SPB7100	7100	PHG SPB7100
SPB2650	2650	PHG SPB2650	SPB7500	7500	PHG SPB7500
SPB2680	2680	PHG SPB2680	SPB8000	8000	PHG SPB8000
SPB2700	2700	PHG SPB2700	-	-	-

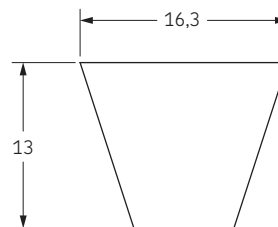

Nabídka obsahuje rovněž nestandardní délky.



Klínové řemeny obalované s úzkým průřezem

SPC

- ▶ Řemeny
- ▶ Řetězy
- ▶ Spojky
- ▶ Pouzdra a náboje
- ▶ Řetězová kola
- ▶ Řemenice
- ▶ Inteligentní nástroje

Oddíl SPC

Typ řemenu	Roztečná délka	Označení	Typ řemenu	Roztečná délka	Označení
	mm			mm	
SPC1700	1700	PHG SPC1700	SPC5000	5000	PHG SPC5000
SPC2000	2000	PHG SPC2000	SPC5300	5300	PHG SPC5300
SPC2120	2120	PHG SPC2120	SPC5600	5600	PHG SPC5600
SPC2240	2240	PHG SPC2240	SPC6000	6000	PHG SPC6000
SPC2360	2360	PHG SPC2360	SPC6300	6300	PHG SPC6300
SPC2500	2500	PHG SPC2500	SPC6700	6700	PHG SPC6700
SPC2650	2650	PHG SPC2650	SPC7100	7100	PHG SPC7100
SPC2800	2800	PHG SPC2800	SPC7500	7500	PHG SPC7500
SPC3000	3000	PHG SPC3000	SPC8000	8000	PHG SPC8000
SPC3150	3150	PHG SPC3150	SPC8500	8500	PHG SPC8500
SPC3350	3350	PHG SPC3350	SPC9000	9000	PHG SPC9000
SPC3550	3550	PHG SPC3550	SPC9500	9500	PHG SPC9500
SPC3750	3750	PHG SPC3750	SPC10000	10000	PHG SPC10000
SPC4000	4000	PHG SPC4000	SPC10600	10600	PHG SPC10600
SPC4250	4250	PHG SPC4250	SPC11200	11200	PHG SPC11200
SPC4500	4500	PHG SPC4500	SPC11800	11800	PHG SPC11800
SPC4750	4750	PHG SPC4750	SPC12500	12500	PHG SPC12500

Nabídka obsahuje rovněž nestandardní délky.

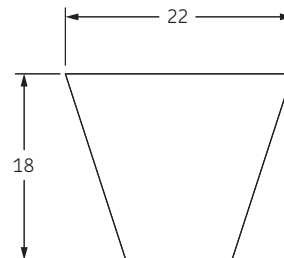



Klínové řemeny obalované s klasickým průřezem

10/Z



Oddíl 10/Z

Roztečná délka			Vnitřní délka			Označení	Roztečná délka			Vnitřní délka			Označení
mm	mm	in	mm	mm	in		mm	mm	in	mm	mm	in	
390	368	14,50	PHG Z14,5	940	927	36,50	PHG Z36,5						
395	381	15,00	PHG Z15	950	940	37,00	PHG Z37						
405	387	15,25	PHG Z15,25	965	953	37,50	PHG Z37,5						
410	394	15,50	PHG Z15,5	975	959	37,75	PHG Z37,75						
420	406	16,00	PHG Z16	980	965	38,00	PHG Z38						
440	419	16,50	PHG Z16,5	990	978	38,50	PHG Z38,5						
445	432	17,00	PHG Z17	1005	984	38,75	PHG Z38,75						
465	445	17,50	PHG Z17,5	1015	991	39,00	PHG Z39						
470	457	18,00	PHG Z18	1025	1003	39,50	PHG Z39,5						
480	470	18,50	PHG Z18,5	1035	1016	40,00	PHG Z40						
495	483	19,00	PHG Z19	1045	1029	40,50	PHG Z40,5						
510	495	19,50	PHG Z19,5	1050	1035	40,75	PHG Z40,75						
520	508	20,00	PHG Z20	1055	1041	41,00	PHG Z41						
530	521	20,50	PHG Z20,5	1075	1054	41,50	PHG Z41,5						
545	533	21,00	PHG Z21	1080	1067	42,00	PHG Z42						
555	540	21,25	PHG Z21,25	1105	1092	43,00	PHG Z43						
570	559	22,00	PHG Z22	1125	1105	43,50	PHG Z43,5						
585	565	22,25	PHG Z22,25	1130	1118	44,00	PHG Z44						
590	572	22,50	PHG Z22,5	1155	1143	45,00	PHG Z45						
600	584	23,00	PHG Z23	1170	1149	45,25	PHG Z45,25						
610	597	23,50	PHG Z23,5	1175	1156	45,50	PHG Z45,5						
620	610	24,00	PHG Z24	1190	1168	46,00	PHG Z46						
630	622	24,50	PHG Z24,5	1200	1181	46,50	PHG Z46,5						
650	635	25,00	PHG Z25	1205	1194	47,00	PHG Z47						
660	648	25,50	PHG Z25,5	1230	1207	47,50	PHG Z47,5						
675	654	25,75	PHG Z25,75	1240	1219	48,00	PHG Z48						
680	660	26,00	PHG Z26	1255	1232	48,50	PHG Z48,5						
685	667	26,25	PHG Z26,25	1270	1245	49,00	PHG Z49						
690	673	26,50	PHG Z26,5	1290	1270	50,00	PHG Z50						
700	686	27,00	PHG Z27	1330	1295	51,00	PHG Z51						
710	692	27,25	PHG Z27,25	1335	1314	51,75	PHG Z51,75						
715	699	27,50	PHG Z27,5	1340	1321	52,00	PHG Z52						
725	711	28,00	PHG Z28	1380	1346	53,00	PHG Z53						
740	724	28,50	PHG Z28,5	1390	1372	54,00	PHG Z54						
750	737	29,00	PHG Z29	1420	1397	55,00	PHG Z55						
770	749	29,50	PHG Z29,5	1440	1422	56,00	PHG Z56						
775	756	29,75	PHG Z29,75	1465	1448	57,00	PHG Z57						
780	762	30,00	PHG Z30	1515	1499	59,00	PHG Z59						
795	775	30,50	PHG Z30,5	1540	1524	60,00	PHG Z60						
800	787	31,00	PHG Z31	1570	1549	61,00	PHG Z61						
820	800	31,50	PHG Z31,5	1595	1575	62,00	PHG Z62						
840	813	32,00	PHG Z32	1620	1600	63,00	PHG Z63						
845	826	32,50	PHG Z32,5	1645	1626	64,00	PHG Z64						
850	838	33,00	PHG Z33	1670	1651	65,00	PHG Z65						
860	851	33,50	PHG Z33,5	1695	1676	66,00	PHG Z66						
875	864	34,00	PHG Z34	1720	1702	67,00	PHG Z67						
890	876	34,50	PHG Z34,5	1750	1727	68,00	PHG Z68						
900	889	35,00	PHG Z35	1770	1753	69,00	PHG Z69						
915	895	35,25	PHG Z35,25	1820	1803	71,00	PHG Z71						
920	902	35,50	PHG Z35,5	1930	1905	75,00	PHG Z75						
925	908	35,75	PHG Z35,75	2000	1981	78,00	PHG Z78						
930	914	36,00	PHG Z36	2025	2007	79,00	PHG Z79						

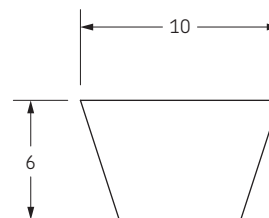

Nabídka obsahuje rovněž nestandardní délky.



Klínové řemeny obalované s klasickým průřezem

13/A

- ▶ Řemeny
- ▶ Retězy
- ▶ Spojky
- ▶ Pouzdra a náboje
- ▶ Řetězová kola
- ▶ Řemenice
- ▶ Inteligentní nástroje

Oddíl 13/A

Rozečná délka		Vnitřní délka		Označení	Rozečná délka		Vnitřní délka		Označení
mm		mm	in		mm		mm	in	
436		406	16,00	PHG A16	1580		1549	61,00	PHG A61
487		457	18,00	PHG A18	1610		1575	62,00	PHG A62
510		483	19,00	PHG A19	1640		1600	63,00	PHG A63
540		508	20,00	PHG A20	1660		1626	64,00	PHG A64
570		533	21,00	PHG A21	1690		1651	65,00	PHG A65
590		559	22,00	PHG A22	1710		1676	66,00	PHG A66
620		584	23,00	PHG A23	1740		1702	67,00	PHG A67
630		597	23,50	PHG A23,5	1750		1715	67,50	PHG A67,5
640		610	24,00	PHG A24	1760		1727	68,00	PHG A68
670		635	25,00	PHG A25	1790		1753	69,00	PHG A69
700		660	26,00	PHG A26	1810		1778	70,00	PHG A70
710		673	26,50	PHG A26,5	1840		1803	71,00	PHG A71
720		686	27,00	PHG A27	1860		1829	72,00	PHG A72
730		699	27,50	PHG A27,5	1890		1854	73,00	PHG A73
740		711	28,00	PHG A28	1920		1880	74,00	PHG A74
770		737	29,00	PHG A29	1940		1905	75,00	PHG A75
780		749	29,50	PHG A29,5	1960		1930	76,00	PHG A76
790		762	30,00	PHG A30	1990		1956	77,00	PHG A77
800		775	30,50	PHG A30,5	2020		1981	78,00	PHG A78
810		781	30,75	PHG A30,75	2050		2007	79,00	PHG A79
820		787	31,00	PHG A31	2070		2032	80,00	PHG A80
820		800	31,50	PHG A31,5	2090		2057	81,00	PHG A81
850		813	32,00	PHG A32	2120		2083	82,00	PHG A82
860		826	32,50	PHG A32,5	2140		2108	83,00	PHG A83
870		838	33,00	PHG A33	2150		2121	83,50	PHG A83,5
880		851	33,50	PHG A33,5	2170		2134	84,00	PHG A84
890		864	34,00	PHG A34	2185		2146	84,50	PHG A84,5
900		876	34,50	PHG A34,5	2200		2159	85,00	PHG A85
920		889	35,00	PHG A35	2220		2184	86,00	PHG A86
930		902	35,50	PHG A35,5	2230		2197	86,50	PHG A86,5
950		914	36,00	PHG A36	2240		2210	87,00	PHG A87
955		921	36,25	PHG A36,25	2270		2235	88,00	PHG A88
970		940	37,00	PHG A37	2300		2261	89,00	PHG A89
980		953	37,50	PHG A37,5	2320		2286	90,00	PHG A90
990		965	38,00	PHG A38	2350		2311	91,00	PHG A91
1010		978	38,50	PHG A38,5	2370		2337	92,00	PHG A92
1020		991	39,00	PHG A39	2400		2362	93,00	PHG A93
1050		1016	40,00	PHG A40	2420		2388	94,00	PHG A94
1060		1029	40,50	PHG A40,5	2450		2413	95,00	PHG A95
1070		1041	41,00	PHG A41	2480		2438	96,00	PHG A96
1085		1054	41,50	PHG A41,5	2500		2464	97,00	PHG A97
1100		1067	42,00	PHG A42	2520		2489	98,00	PHG A98
1110		1080	42,50	PHG A42,5	2550		2515	99,00	PHG A99
1130		1092	43,00	PHG A43	2570		2540	100,00	PHG A100
1150		1118	44,00	PHG A44	2630		2591	102,00	PHG A102
1180		1143	45,00	PHG A45	2680		2642	104,00	PHG A104
1180		1143	45,00	PHG A45	2700		2667	105,00	PHG A105
1185		1149	45,25	PHG A45,25	2750		2718	107,00	PHG A107
1200		1168	46,00	PHG A46	2780		2743	108,00	PHG A108
1215		1181	46,50	PHG A46,5	2830		2794	110,00	PHG A110
1230		1194	47,00	PHG A47	2880		2845	112,00	PHG A112
1240		1207	47,50	PHG A47,5	2930		2896	114,00	PHG A114
1250		1219	48,00	PHG A48	2980		2946	116,00	PHG A116
1265		1232	48,50	PHG A48,5	3030		2997	118,00	PHG A118
1280		1245	49,00	PHG A49	3080		3048	120,00	PHG A120
1300		1270	50,00	PHG A50	3190		3150	124,00	PHG A124
1315		1283	50,50	PHG A50,5	3290		3251	128,00	PHG A128
1330		1295	51,00	PHG A51	3340		3302	130,00	PHG A130
1360		1321	52,00	PHG A52	3390		3353	132,00	PHG A132
1380		1346	53,00	PHG A53	3490		3454	136,00	PHG A136
1410		1372	54,00	PHG A54	3590		3556	140,00	PHG A140
1430		1397	55,00	PHG A55	3690		3658	144,00	PHG A144
1460		1422	56,00	PHG A56	3800		3759	148,00	PHG A148
1480		1448	57,00	PHG A57	3840		3810	150,00	PHG A150
1510		1473	58,00	PHG A58	4043		4013	158,00	PHG A158
1530		1499	59,00	PHG A59	4424		4394	173,00	PHG A173
1550		1524	60,00	PHG A60	4780		4750	187,00	PHG A187

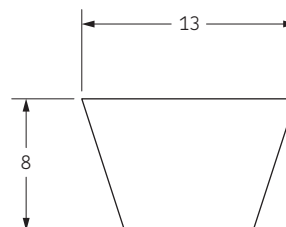

Nabídka obsahuje rovněž nestandardní délky.



Klínové řemeny obalované s klasickým průřezem

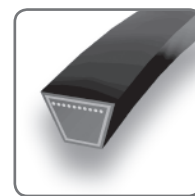

17/B

Oddíl 17/B

Rozečtná délka			Vnitřní délka			Označení	Rozečtná délka			Vnitřní délka			Označení
mm	mm	in	mm	mm	in		mm	mm	in	mm	mm	in	
624	584	23,00	PHG B23	1490	1448	57,00	PHG B57	2872	2832	111,50	PHG B111,5		
650	610	24,00	PHG B24	1510	1473	58,00	PHG B58	2890	2845	112,00	PHG B112		
675	635	25,00	PHG B25	1540	1499	59,00	PHG B59	2940	2896	114,00	PHG B114		
700	660	26,00	PHG B26	1560	1524	60,00	PHG B60	2960	2921	115,00	PHG B115		
715	673	26,50	PHG B26,5	1590	1549	61,00	PHG B61	2990	2946	116,00	PHG B116		
730	686	27,00	PHG B27	1620	1575	62,00	PHG B62	3040	2997	118,00	PHG B118		
750	711	28,00	PHG B28	1640	1600	63,00	PHG B63	3090	3048	120,00	PHG B120		
760	724	28,50	PHG B28,5	1655	1613	63,50	PHG B63,5	3140	3099	122,00	PHG B122		
770	737	29,00	PHG B29	1670	1626	64,00	PHG B64	3200	3150	124,00	PHG B124		
785	749	29,50	PHG B29,5	1690	1651	65,00	PHG B65	3240	3200	126,00	PHG B126		
800	762	30,00	PHG B30	1720	1676	66,00	PHG B66	3290	3251	128,00	PHG B128		
830	787	31,00	PHG B31	1740	1702	67,00	PHG B67	3350	3302	130,00	PHG B130		
845	800	31,50	PHG B31,5	1760	1727	68,00	PHG B68	3400	3353	132,00	PHG B132		
860	813	32,00	PHG B32	1800	1753	69,00	PHG B69	3450	3404	134,00	PHG B134		
863	819	32,25	PHG B32,25	1810	1765	69,50	PHG B69,5	3500	3454	136,00	PHG B136		
866	826	32,50	PHG B32,5	1820	1778	70,00	PHG B70	3550	3505	138,00	PHG B138		
880	838	33,00	PHG B33	1850	1803	71,00	PHG B71	3600	3556	140,00	PHG B140		
895	851	33,50	PHG B33,5	1870	1829	72,00	PHG B72	3650	3607	142,00	PHG B142		
900	857	33,75	PHG B33,75	1900	1854	73,00	PHG B73	3700	3658	144,00	PHG B144		
910	864	34,00	PHG B34	1920	1880	74,00	PHG B74	3750	3708	146,00	PHG B146		
920	876	34,50	PHG B34,5	1950	1905	75,00	PHG B75	3800	3759	148,00	PHG B148		
930	889	35,00	PHG B35	1970	1930	76,00	PHG B76	3850	3810	150,00	PHG B150		
945	902	35,50	PHG B35,5	2000	1956	77,00	PHG B77	3870	3835	151,00	PHG B151		
950	908	35,75	PHG B35,75	2020	1981	78,00	PHG B78	3900	3861	152,00	PHG B152		
960	914	36,00	PHG B36	2050	2007	79,00	PHG B79	3950	3912	154,00	PHG B154		
965	921	36,25	PHG B36,25	2070	2032	80,00	PHG B80	4010	3962	156,00	PHG B156		
970	927	36,50	PHG B36,5	2100	2057	81,00	PHG B81	4060	4013	158,00	PHG B158		
980	940	37,00	PHG B37	2130	2083	82,00	PHG B82	4110	4064	160,00	PHG B160		
990	953	37,50	PHG B37,5	2150	2108	83,00	PHG B83	4160	4115	162,00	PHG B162		
1000	965	38,00	PHG B38	2165	2121	83,50	PHG B83,5	4200	4166	164,00	PHG B164		
1020	978	38,50	PHG B38,5	2180	2134	84,00	PHG B84	4230	4191	165,00	PHG B165		
1030	991	39,00	PHG B39	2200	2159	85,00	PHG B85	4280	4242	167,00	PHG B167		
1045	1003	39,50	PHG B39,5	2230	2184	86,00	PHG B86	4360	4318	170,00	PHG B170		
1060	1016	40,00	PHG B40	2250	2210	87,00	PHG B87	4430	4394	173,00	PHG B173		
1070	1029	40,50	PHG B40,5	2280	2235	88,00	PHG B88	4490	4445	175,00	PHG B175		
1080	1041	41,00	PHG B41	2300	2261	89,00	PHG B89	4540	4496	177,00	PHG B177		
1090	1054	41,50	PHG B41,5	2330	2286	90,00	PHG B90	4610	4572	180,00	PHG B180		
1100	1067	42,00	PHG B42	2350	2311	91,00	PHG B91	4740	4699	185,00	PHG B185		
1115	1080	42,50	PHG B42,5	2380	2337	92,00	PHG B92	4800	4750	187,00	PHG B187		
1130	1092	43,00	PHG B43	2400	2362	93,00	PHG B93	5000	4953	195,00	PHG B195		
1140	1099	43,25	PHG B43,25	2420	2388	94,00	PHG B94	5044	5004	197,00	PHG B197		
1160	1118	44,00	PHG B44	2435	2400	94,50	PHG B94,5	5220	5182	204,00	PHG B204		
1180	1143	45,00	PHG B45	2450	2413	95,00	PHG B95	5340	5283	208,00	PHG B208		
1195	1156	45,50	PHG B45,5	2480	2438	96,00	PHG B96	5370	5334	210,00	PHG B210		
1210	1168	46,00	PHG B46	2490	2451	96,50	PHG B96,5	5630	5588	220,00	PHG B220		
1225	1181	46,50	PHG B46,5	2500	2464	97,00	PHG B97	5760	5715	225,00	PHG B225		
1240	1194	47,00	PHG B47	2530	2489	98,00	PHG B98	6040	5994	236,00	PHG B236		
1260	1219	48,00	PHG B48	2560	2515	99,00	PHG B99	6140	6096	240,00	PHG B240		
1290	1245	49,00	PHG B49	2580	2540	100,00	PHG B100	6340	6299	248,00	PHG B248		
1310	1270	50,00	PHG B50	2610	2565	101,00	PHG B101	6750	6706	264,00	PHG B264		
1340	1295	51,00	PHG B51	2630	2591	102,00	PHG B102	6900	6858	270,00	PHG B270		
1370	1321	52,00	PHG B52	2660	2616	103,00	PHG B103	7025	6985	275,00	PHG B275		
1380	1334	52,50	PHG B52,5	2680	2642	104,00	PHG B104	7050	7010	276,00	PHG B276		
1390	1346	53,00	PHG B53	2700	2667	105,00	PHG B105	7150	7112	280,00	PHG B280		
1400	1359	53,50	PHG B53,5	2740	2692	106,00	PHG B106	7660	7620	300,00	PHG B300		
1410	1372	54,00	PHG B54	2760	2718	107,00	PHG B107	8040	8001	315,00	PHG B315		
1440	1397	55,00	PHG B55	2790	2743	108,00	PHG B108	-	-	-	-		
1460	1422	56,00	PHG B56	2840	2794	110,00	PHG B110	-	-	-	-		

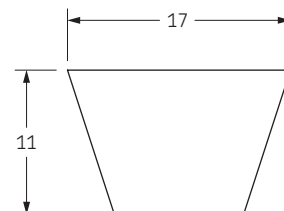

Nabídka obsahuje rovněž nestandardní délky.



Klínové řemeny obalované s klasickým průřezem

22/C

- ▶ Řemeny
- ▶ Řetězy
- ▶ Spojky
- ▶ Pouzdra a náboje
- ▶ Řetězová kola
- ▶ Řemenice
- ▶ Inteligentní nástroje

Oddíl 22/C

Roztečná délka		Vnitřní délka		Označení	Roztečná délka		Vnitřní délka		Označení
mm		mm	in		mm	mm	mm	in	
1126		1067	42,00	PHG C42	2700	2642	104,00	PHG C104	
1150		1092	43,00	PHG C43	2720	2667	105,00	PHG C105	
1250		1194	47,00	PHG C47	2740	2692	106,00	PHG C106	
1280		1219	48,00	PHG C48	2800	2743	108,00	PHG C108	
1300		1245	49,00	PHG C49	2850	2794	110,00	PHG C110	
1325		1270	50,00	PHG C50	2900	2845	112,00	PHG C112	
1349		1289	50,75	PHG C50,75	2950	2896	114,00	PHG C114	
1350		1295	51,00	PHG C51	2980	2921	115,00	PHG C115	
1370		1321	52,00	PHG C52	2990	2934	115,50	PHG C115,5	
1400		1346	53,00	PHG C53	3000	2946	116,00	PHG C116	
1430		1372	54,00	PHG C54	3050	2997	118,00	PHG C118	
1450		1397	55,00	PHG C55	3100	3048	120,00	PHG C120	
1480		1422	56,00	PHG C56	3160	3099	122,00	PHG C122	
1500		1448	57,00	PHG C57	3210	3150	124,00	PHG C124	
1530		1473	58,00	PHG C58	3270	3200	126,00	PHG C126	
1560		1499	59,00	PHG C59	3310	3251	128,00	PHG C128	
1580		1524	60,00	PHG C60	3360	3302	130,00	PHG C130	
1610		1549	61,00	PHG C61	3410	3353	132,00	PHG C132	
1630		1575	62,00	PHG C62	3460	3404	134,00	PHG C134	
1650		1600	63,00	PHG C63	3520	3454	136,00	PHG C136	
1700		1651	65,00	PHG C65	3560	3505	138,00	PHG C138	
1730		1676	66,00	PHG C66	3610	3556	140,00	PHG C140	
1760		1702	67,00	PHG C67	3660	3607	142,00	PHG C142	
1780		1727	68,00	PHG C68	3710	3658	144,00	PHG C144	
1810		1753	69,00	PHG C69	3760	3708	146,00	PHG C146	
1830		1778	70,00	PHG C70	3820	3759	148,00	PHG C148	
1860		1803	71,00	PHG C71	3870	3810	150,00	PHG C150	
1880		1829	72,00	PHG C72	3920	3861	152,00	PHG C152	
1910		1854	73,00	PHG C73	4060	4013	158,00	PHG C158	
1930		1880	74,00	PHG C74	4170	4115	162,00	PHG C162	
1940		1892	74,50	PHG C74,5	4280	4216	166,00	PHG C166	
1950		1905	75,00	PHG C75	4300	4242	167,00	PHG C167	
1990		1930	76,00	PHG C76	4320	4267	168,00	PHG C168	
2000		1943	76,50	PHG C76,5	4450	4394	173,00	PHG C173	
2010		1956	77,00	PHG C77	4500	4445	175,00	PHG C175	
2040		1981	78,00	PHG C78	4560	4496	177,00	PHG C177	
2060		2007	79,00	PHG C79	4630	4572	180,00	PHG C180	
2090		2032	80,00	PHG C80	4810	4750	187,00	PHG C187	
2110		2057	81,00	PHG C81	4880	4826	190,00	PHG C190	
2140		2083	82,00	PHG C82	5010	4953	195,00	PHG C195	
2160		2108	83,00	PHG C83	5060	5004	197,00	PHG C197	
2175		2121	83,50	PHG C83,5	5240	5182	204,00	PHG C204	
2190		2134	84,00	PHG C84	5340	5283	208,00	PHG C208	
2205		2146	84,50	PHG C84,5	5380	5334	210,00	PHG C210	
2220		2159	85,00	PHG C85	5640	5588	220,00	PHG C220	
2240		2184	86,00	PHG C86	5770	5715	225,00	PHG C225	
2270		2210	87,00	PHG C87	6050	5994	236,00	PHG C236	
2290		2235	88,00	PHG C88	6100	6045	238,00	PHG C238	
2320		2261	89,00	PHG C89	6150	6096	240,00	PHG C240	
2340		2286	90,00	PHG C90	6360	6299	248,00	PHG C248	
2390		2337	92,00	PHG C92	6535	6477	255,00	PHG C255	
2420		2362	93,00	PHG C93	6760	6706	264,00	PHG C264	
2440		2388	94,00	PHG C94	6910	6858	270,00	PHG C270	
2470		2413	95,00	PHG C95	7170	7112	280,00	PHG C280	
2490		2438	96,00	PHG C96	7550	7493	295,00	PHG C295	
2505		2451	96,50	PHG C96,5	7680	7620	300,00	PHG C300	
2520		2464	97,00	PHG C97	8060	8001	315,00	PHG C315	
2550		2489	98,00	PHG C98	8390	8331	328,00	PHG C328	
2570		2515	99,00	PHG C99	8440	8382	330,00	PHG C330	
2600		2540	100,00	PHG C100	9200	9144	360,00	PHG C360	
2620		2565	101,00	PHG C101	9970	9906	390,00	PHG C390	
2650		2591	102,00	PHG C102	10670	10617	418,00	PHG C418	

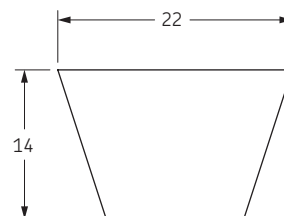

Nabídka obsahuje rovněž nestandardní délky.

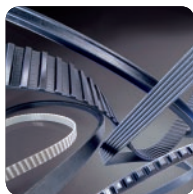

Klínové řemeny obalované s klasickým průřezem

32/D



Oddíl 32/D

Roztečná délka			Označení	Roztečná délka			Označení
mm	mm	in		mm	mm	in	
2560	2489	98,00	PHG D98	5400	5334	210,00	PHG D210
2720	2642	104,00	PHG D104	5670	5588	220,00	PHG D220
2740	2667	105,00	PHG D105	5790	5715	225,00	PHG D225
2870	2794	110,00	PHG D110	6070	5994	236,00	PHG D236
3080	2997	118,00	PHG D118	6170	6096	240,00	PHG D240
3130	3048	120,00	PHG D120	6380	6299	248,00	PHG D248
3225	3150	124,00	PHG D124	6425	6350	250,00	PHG D250
3330	3251	128,00	PHG D128	6560	6477	255,00	PHG D255
3430	3353	132,00	PHG D132	6780	6706	264,00	PHG D264
3530	3454	136,00	PHG D136	6910	6833	269,00	PHG D269
3555	3480	137,00	PHG D137	6940	6858	270,00	PHG D270
3640	3556	140,00	PHG D140	7190	7112	280,00	PHG D280
3730	3658	144,00	PHG D144	7320	7239	285,00	PHG D285
3830	3759	148,00	PHG D148	7650	7569	298,00	PHG D298
4080	4013	158,00	PHG D158	7700	7620	300,00	PHG D300
4190	4115	162,00	PHG D162	8080	8001	315,00	PHG D315
4320	4242	167,00	PHG D167	8410	8331	328,00	PHG D328
4395	4318	170,00	PHG D170	8460	8382	330,00	PHG D330
4470	4394	173,00	PHG D173	9070	8992	354,00	PHG D354
4580	4496	177,00	PHG D177	9220	9144	360,00	PHG D360
4650	4572	180,00	PHG D180	9580	9500	374,00	PHG D374
4830	4750	187,00	PHG D187	9980	9906	390,00	PHG D390
5030	4953	195,00	PHG D195	10085	10008	394,00	PHG D394
5080	5004	197,00	PHG D197	10700	10617	418,00	PHG D418
5360	5283	208,00	PHG D208	12190	12116	477,00	PHG D477

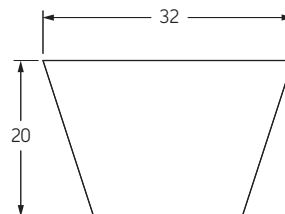

Nabídka obsahuje rovněž nestandardní délky.

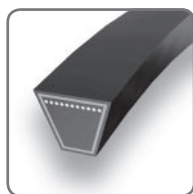

Úzké klínové řemeny obalované

3V, 5V, 8V

- ▶ Řemeny
- ▶ Řetězy
- ▶ Spojky
- ▶ Pouzdra a náboje
- ▶ Řetězová kola
- ▶ Řemenice
- ▶ Inteligentní nástroje

Oddíl 3V/9J

Vnější délka		Označení	Vnější délka		Označení
mm	in		mm	in	
635	25,0	PHG 3V250	1600	63,0	PHG 3V630
673	26,5	PHG 3V265	1702	67,0	PHG 3V670
711	28,0	PHG 3V280	1803	71,0	PHG 3V710
762	30,0	PHG 3V300	1905	75,0	PHG 3V750
800	31,5	PHG 3V315	2032	80,0	PHG 3V800
851	33,5	PHG 3V335	2159	85,0	PHG 3V850
902	35,5	PHG 3V355	2286	90,0	PHG 3V900
953	37,5	PHG 3V375	2413	95,0	PHG 3V950
1016	40,0	PHG 3V400	2540	100,0	PHG 3V1000
1080	42,5	PHG 3V425	2692	106,0	PHG 3V1060
1143	45,0	PHG 3V450	2845	112,0	PHG 3V1120
1207	47,5	PHG 3V475	2997	118,0	PHG 3V1180
1270	50,0	PHG 3V500	3175	125,0	PHG 3V1250
1346	53,0	PHG 3V530	3353	132,0	PHG 3V1320
1422	56,0	PHG 3V560	3556	140,0	PHG 3V1400
1524	60,0	PHG 3V600	-	-	-

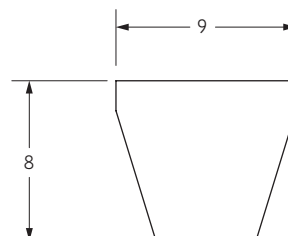

Oddíl 5V/15J

Vnější délka		Označení	Vnější délka		Označení
mm	in		mm	in	
1346	53,0	PHG 5V530	3556	140,0	PHG 5V1400
1422	56,0	PHG 5V560	3810	150,0	PHG 5V1500
1524	60,0	PHG 5V600	4064	160,0	PHG 5V1600
1600	63,0	PHG 5V630	4318	170,0	PHG 5V1700
1702	67,0	PHG 5V670	4572	180,0	PHG 5V1800
1803	71,0	PHG 5V710	4826	190,0	PHG 5V1900
1905	75,0	PHG 5V750	5080	200,0	PHG 5V2000
2032	80,0	PHG 5V800	5385	212,0	PHG 5V2120
2159	85,0	PHG 5V850	5690	224,0	PHG 5V2240
2286	90,0	PHG 5V900	5994	236,0	PHG 5V2360
2413	95,0	PHG 5V950	6350	250,0	PHG 5V2500
2540	100,0	PHG 5V1000	6731	265,0	PHG 5V2650
2692	106,0	PHG 5V1060	7112	280,0	PHG 5V2800
2845	112,0	PHG 5V1120	7620	300,0	PHG 5V3000
2997	118,0	PHG 5V1180	8001	315,0	PHG 5V3150
3175	125,0	PHG 5V1250	8509	335,0	PHG 5V3350
3353	132,0	PHG 5V1320	9017	355,0	PHG 5V3550

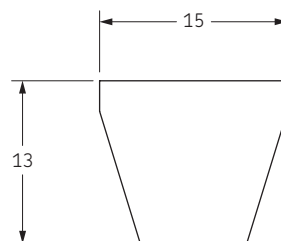

Oddíl 8V/25J

Vnější délka		Označení	Vnější délka		Označení
mm	in		mm	in	
2540	100,0	PHG 8V1000	5994	236,0	PHG 8V2360
2692	106,0	PHG 8V1060	6350	250,0	PHG 8V2500
2845	112,0	PHG 8V1120	6731	265,0	PHG 8V2650
2997	118,0	PHG 8V1180	7112	280,0	PHG 8V2800
3175	125,0	PHG 8V1250	7620	300,0	PHG 8V3000
3353	132,0	PHG 8V1320	8001	315,0	PHG 8V3150
3556	140,0	PHG 8V1400	8509	335,0	PHG 8V3350
3810	150,0	PHG 8V1500	9017	355,0	PHG 8V3550
4064	160,0	PHG 8V1600	9525	375,0	PHG 8V3750
4318	170,0	PHG 8V1700	10160	400,0	PHG 8V4000
4572	180,0	PHG 8V1800	10795	425,0	PHG 8V4250
4826	190,0	PHG 8V1900	11430	450,0	PHG 8V4500
5080	200,0	PHG 8V2000	12065	475,0	PHG 8V4750
5385	212,0	PHG 8V2120	12700	500,0	PHG 8V5000
5690	224,0	PHG 8V2240	-	-	-

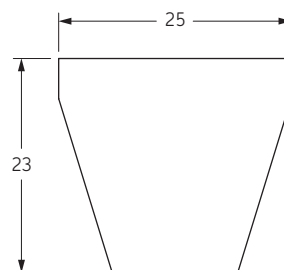

Nabídka obsahuje rovněž nestandardní délky.



Ozubené klínové řemeny s úzkým průřezem řezané

XPZ

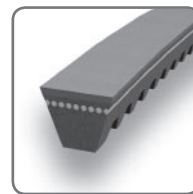

Oddíl XPZ ozubené řezané

Typ řemenu	Roztečná délka mm	Označení	Typ řemenu	Roztečná délka mm	Označení
XPZ630	630	PHG XPZ630	XPZ1202	1202	PHG XPZ1202
XPZ637	637	PHG XPZ637	XPZ1212	1212	PHG XPZ1212
XPZ662	662	PHG XPZ662	XPZ1237	1237	PHG XPZ1237
XPZ670	670	PHG XPZ670	XPZ1250	1250	PHG XPZ1250
XPZ687	687	PHG XPZ687	XPZ1262	1262	PHG XPZ1262
XPZ710	710	PHG XPZ710	XPZ1270	1270	PHG XPZ1270
XPZ737	737	PHG XPZ737	XPZ1287	1287	PHG XPZ1287
XPZ750	750	PHG XPZ750	XPZ1312	1312	PHG XPZ1312
XPZ760	760	PHG XPZ760	XPZ1320	1320	PHG XPZ1320
XPZ762	762	PHG XPZ762	XPZ1337	1337	PHG XPZ1337
XPZ772	772	PHG XPZ772	XPZ1340	1340	PHG XPZ1340
XPZ787	787	PHG XPZ787	XPZ1362	1362	PHG XPZ1362
XPZ800	800	PHG XPZ800	XPZ1400	1400	PHG XPZ1400
XPZ812	812	PHG XPZ812	XPZ1412	1412	PHG XPZ1412
XPZ837	837	PHG XPZ837	XPZ1420	1420	PHG XPZ1420
XPZ850	850	PHG XPZ850	XPZ1487	1487	PHG XPZ1487
XPZ862	862	PHG XPZ862	XPZ1500	1500	PHG XPZ1500
XPZ875	875	PHG XPZ875	XPZ1512	1512	PHG XPZ1512
XPZ887	887	PHG XPZ887	XPZ1520	1520	PHG XPZ1520
XPZ900	900	PHG XPZ900	XPZ1537	1537	PHG XPZ1537
XPZ912	912	PHG XPZ912	XPZ1587	1587	PHG XPZ1587
XPZ925	925	PHG XPZ925	XPZ1600	1600	PHG XPZ1600
XPZ937	937	PHG XPZ937	XPZ1700	1700	PHG XPZ1700
XPZ950	950	PHG XPZ950	XPZ1800	1800	PHG XPZ1800
XPZ962	962	PHG XPZ962	XPZ1850	1850	PHG XPZ1850
XPZ987	987	PHG XPZ987	XPZ1900	1900	PHG XPZ1900
XPZ1000	1000	PHG XPZ1000	XPZ2000	2000	PHG XPZ2000
XPZ1010	1010	PHG XPZ1010	XPZ2030	2030	PHG XPZ2030
XPZ1012	1012	PHG XPZ1012	XPZ2120	2120	PHG XPZ2120
XPZ1037	1037	PHG XPZ1037	XPZ2240	2240	PHG XPZ2240
XPZ1060	1060	PHG XPZ1060	XPZ2280	2280	PHG XPZ2280
XPZ1077	1077	PHG XPZ1077	XPZ2360	2360	PHG XPZ2360
XPZ1080	1080	PHG XPZ1080	XPZ2410	2410	PHG XPZ2410
XPZ1087	1087	PHG XPZ1087	XPZ2500	2500	PHG XPZ2500
XPZ1112	1112	PHG XPZ1112	XPZ2540	2540	PHG XPZ2540
XPZ1120	1120	PHG XPZ1120	XPZ2650	2650	PHG XPZ2650
XPZ1137	1137	PHG XPZ1137	XPZ2800	2800	PHG XPZ2800
XPZ1140	1140	PHG XPZ1140	XPZ3000	3000	PHG XPZ3000
XPZ1162	1162	PHG XPZ1162	XPZ3150	3150	PHG XPZ3150
XPZ1180	1180	PHG XPZ1180	XPZ3350	3350	PHG XPZ3350
XPZ1187	1187	PHG XPZ1187	XPZ3550	3550	PHG XPZ3550
XPZ1200	1200	PHG XPZ1200	-	-	-

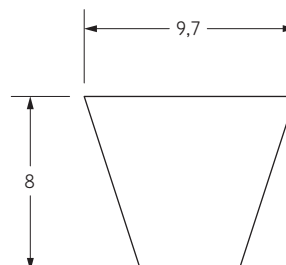

Nabídka obsahuje rovněž nestandardní délky.

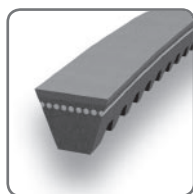

Ozubené klínové řemeny s úzkým průřezem řezané

XPA, XPB, XPC

- ▶ Řemeny
- ▶ Řetězy
- ▶ Spojky
- ▶ Pouzdra a náboje
- ▶ Řetězová kola
- ▶ Řemenice
- ▶ Inteligentní nástroje

Oddíl XPA ozubené řezané

Typ řemenu	Roztečná délka mm	Označení	Typ řemenu	Roztečná délka mm	Označení
XPA757	757	PHG XPA757	XPA1282	1282	PHG XPA1282
XPA782	782	PHG XPA782	XPA1307	1307	PHG XPA1307
XPA800	800	PHG XPA800	XPA1320	1320	PHG XPA1320
XPA832	832	PHG XPA832	XPA1332	1332	PHG XPA1332
XPA850	850	PHG XPA850	XPA1357	1357	PHG XPA1357
XPA857	857	PHG XPA857	XPA1400	1400	PHG XPA1400
XPA882	882	PHG XPA882	XPA1482	1482	PHG XPA1482
XPA900	900	PHG XPA900	XPA1500	1500	PHG XPA1500
XPA907	907	PHG XPA907	XPA1507	1507	PHG XPA1507
XPA932	932	PHG XPA932	XPA1532	1532	PHG XPA1532
XPA950	950	PHG XPA950	XPA1582	1582	PHG XPA1582
XPA957	957	PHG XPA957	XPA1600	1600	PHG XPA1600
XPA982	982	PHG XPA982	XPA1700	1700	PHG XPA1700
XPA1000	1000	PHG XPA1000	XPA1800	1800	PHG XPA1800
XPA1007	1007	PHG XPA1007	XPA1900	1900	PHG XPA1900
XPA1030	1030	PHG XPA1030	XPA2000	2000	PHG XPA2000
XPA1060	1060	PHG XPA1060	XPA2120	2120	PHG XPA2120
XPA1082	1082	PHG XPA1082	XPA2240	2240	PHG XPA2240
XPA1107	1107	PHG XPA1107	XPA2360	2360	PHG XPA2360
XPA1120	1120	PHG XPA1120	XPA2500	2500	PHG XPA2500
XPA1157	1157	PHG XPA1157	XPA2650	2650	PHG XPA2650
XPA1180	1180	PHG XPA1180	XPA2800	2800	PHG XPA2800
XPA1207	1207	PHG XPA1207	XPA3000	3000	PHG XPA3000
XPA1232	1232	PHG XPA1232	XPA3150	3150	PHG XPA3150
XPA1250	1250	PHG XPA1250	XPA3350	3350	PHG XPA3350
XPA1257	1257	PHG XPA1257	XPA3550	3550	PHG XPA3550

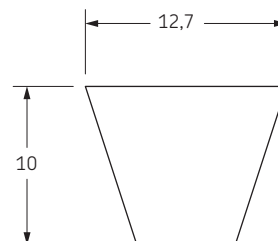

Oddíl XPB ozubené řezané

Typ řemenu	Roztečná délka mm	Označení	Typ řemenu	Roztečná délka mm	Označení
XPB1250	1250	PHG XPB1250	XPB2120	2120	PHG XPB2120
XPB1260	1260	PHG XPB1260	XPB2150	2150	PHG XPB2150
XPB1320	1320	PHG XPB1320	XPB2240	2240	PHG XPB2240
XPB1340	1340	PHG XPB1340	XPB2280	2280	PHG XPB2280
XPB1400	1400	PHG XPB1400	XPB2360	2360	PHG XPB2360
XPB1410	1410	PHG XPB1410	XPB2500	2500	PHG XPB2500
XPB1500	1500	PHG XPB1500	XPB2530	2530	PHG XPB2530
XPB1590	1590	PHG XPB1590	XPB2650	2650	PHG XPB2650
XPB1600	1600	PHG XPB1600	XPB2680	2680	PHG XPB2680
XPB1690	1690	PHG XPB1690	XPB2800	2800	PHG XPB2800
XPB1700	1700	PHG XPB1700	XPB3000	3000	PHG XPB3000
XPB1800	1800	PHG XPB1800	XPB3150	3150	PHG XPB3150
XPB1900	1900	PHG XPB1900	XPB3350	3350	PHG XPB3350
XPB2000	2000	PHG XPB2000	XPB3550	3550	PHG XPB3550
XPB2020	2020	PHG XPB2020	-	-	-

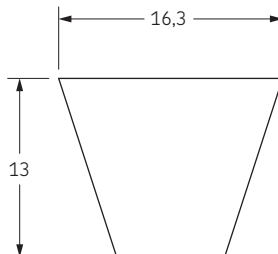

Oddíl XPC ozubené řezané

Typ řemenu	Roztečná délka mm	Označení	Typ řemenu	Roztečná délka mm	Označení
XPC2000	2000	PHG XPC2000	XPC2800	2800	PHG XPC2800
XPC2120	2120	PHG XPC2120	XPC3000	3000	PHG XPC3000
XPC2240	2240	PHG XPC2240	XPC3150	3150	PHG XPC3150
XPC2360	2360	PHG XPC2360	XPC3350	3350	PHG XPC3350
XPC2500	2500	PHG XPC2500	XPC3550	3550	PHG XPC3550
XPC2650	2650	PHG XPC2650	-	-	-

Nabídka obsahuje rovněž nestandardní délky.

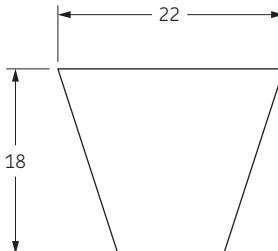



Ozubené klínové řemeny s klasickým průřezem řezané

X10/ZX, X13/AX

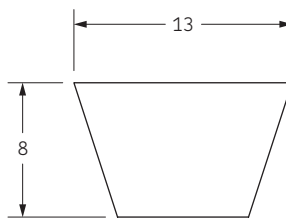
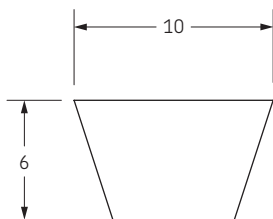
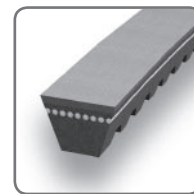

Oddíl X10/ZX ozubené řezané

Rozečná délka			Vnitřní délka			Označení		
mm	mm	in	mm	mm	in	mm	mm	in
405	387	15,25	PHG ZX15.25	950	940	37,00	PHG ZX37	
420	406	16,00	PHG ZX16	965	953	37,50	PHG ZX37.5	
465	445	17,50	PHG ZX17.5	975	959	37,75	PHG ZX37.75	
470	457	18,00	PHG ZX18	980	965	38,00	PHG ZX38	
495	483	19,00	PHG ZX19	1005	984	38,75	PHG ZX38.75	
555	540	21,25	PHG ZX21.25	1025	1003	39,50	PHG ZX39.5	
585	565	22,25	PHG ZX22.25	1035	1016	40,00	PHG ZX40	
590	572	22,50	PHG ZX22.5	1050	1035	40,75	PHG ZX40.75	
600	584	23,00	PHG ZX23	1055	1041	41,00	PHG ZX41	
620	610	24,00	PHG ZX24	1075	1054	41,50	PHG ZX41.5	
650	635	25,00	PHG ZX25	1080	1067	42,00	PHG ZX42	
675	654	25,75	PHG ZX25.75	1105	1092	43,00	PHG ZX43	
680	660	26,00	PHG ZX26	1125	1105	43,50	PHG ZX43.5	
685	667	26,25	PHG ZX26.25	1130	1118	44,00	PHG ZX44	
690	673	26,50	PHG ZX26.5	1155	1143	45,00	PHG ZX45	
700	686	27,00	PHG ZX27	1170	1149	45,25	PHG ZX45.25	
710	692	27,25	PHG ZX27.25	1200	1181	46,50	PHG ZX46.5	
725	711	28,00	PHG ZX28	1230	1207	47,50	PHG ZX47.5	
740	724	28,50	PHG ZX28.5	1255	1232	48,50	PHG ZX48.5	
750	737	29,00	PHG ZX29	1290	1270	50,00	PHG ZX50	
770	749	29,50	PHG ZX29.5	1340	1321	52,00	PHG ZX52	
775	756	29,75	PHG ZX29.75	1380	1346	53,00	PHG ZX53	
780	762	30,00	PHG ZX30	1390	1372	54,00	PHG ZX54	
800	787	31,00	PHG ZX31	1420	1397	55,00	PHG ZX55	
820	800	31,50	PHG ZX31.5	1465	1448	57,00	PHG ZX57	
840	813	32,00	PHG ZX32	1515	1499	59,00	PHG ZX59	
845	826	32,50	PHG ZX32.5	1570	1549	61,00	PHG ZX61	
850	838	33,00	PHG ZX33	1620	1600	63,00	PHG ZX63	
860	851	33,50	PHG ZX33.5	1670	1651	65,00	PHG ZX65	
875	864	34,00	PHG ZX34	1695	1676	66,00	PHG ZX66	
890	876	34,50	PHG ZX34.5	1720	1702	67,00	PHG ZX67	
900	889	35,00	PHG ZX35	1750	1727	68,00	PHG ZX68	
915	895	35,25	PHG ZX35.25	1770	1753	69,00	PHG ZX69	
920	902	35,50	PHG ZX35.5	1820	1803	71,00	PHG ZX71	
930	914	36,00	PHG ZX36	2000	1981	78,00	PHG ZX78	
940	927	36,50	PHG ZX36.5	-	-	-	-	

Oddíl X13/AX ozubené řezané

Rozečná délka			Vnitřní délka			Označení		
mm	mm	in	mm	mm	in	mm	mm	in
570	533	21,00	PHG AX21	1580	1549	61,00	PHG AX61	
590	559	22,00	PHG AX22	1610	1575	62,00	PHG AX62	
620	584	23,00	PHG AX23	1640	1600	63,00	PHG AX63	
630	597	23,50	PHG AX23,5	1660	1626	64,00	PHG AX64	
640	610	24,00	PHG AX24	1690	1651	65,00	PHG AX65	
670	635	25,00	PHG AX25	1710	1676	66,00	PHG AX66	
700	660	26,00	PHG AX26	1740	1702	67,00	PHG AX67	
710	673	26,50	PHG AX26,5	1760	1727	68,00	PHG AX68	
720	686	27,00	PHG AX27	1790	1753	69,00	PHG AX69	
740	711	28,00	PHG AX28	1810	1778	70,00	PHG AX70	
770	737	29,00	PHG AX29	1840	1803	71,00	PHG AX71	
790	762	30,00	PHG AX30	1860	1829	72,00	PHG AX72	
820	787	31,00	PHG AX31	1890	1854	73,00	PHG AX73	
850	813	32,00	PHG AX32	1920	1880	74,00	PHG AX74	
870	838	33,00	PHG AX33	1940	1905	75,00	PHG AX75	
890	864	34,00	PHG AX34	1960	1930	76,00	PHG AX76	
920	889	35,00	PHG AX35	1990	1956	77,00	PHG AX77	
930	902	35,50	PHG AX35,5	2020	1981	78,00	PHG AX78	
950	914	36,00	PHG AX36	2050	2007	79,00	PHG AX79	
970	940	37,00	PHG AX37	2070	2032	80,00	PHG AX80	
980	953	37,50	PHG AX37,5	2090	2057	81,00	PHG AX81	
990	965	38,00	PHG AX38	2120	2083	82,00	PHG AX82	
1020	991	39,00	PHG AX39	2140	2108	83,00	PHG AX83	
1050	1016	40,00	PHG AX40	2170	2134	84,00	PHG AX84	
1070	1041	41,00	PHG AX41	2200	2159	85,00	PHG AX85	
1085	1054	41,50	PHG AX41,5	2220	2184	86,00	PHG AX86	
1100	1067	42,00	PHG AX42	2240	2210	87,00	PHG AX87	
1130	1092	43,00	PHG AX43	2270	2235	88,00	PHG AX88	
1150	1118	44,00	PHG AX44	2300	2261	89,00	PHG AX89	
1180	1143	45,00	PHG AX45	2320	2286	90,00	PHG AX90	
1190	1156	45,50	PHG AX45,5	2350	2311	91,00	PHG AX91	
1200	1168	46,00	PHG AX46	2400	2362	93,00	PHG AX93	
1230	1194	47,00	PHG AX47	2420	2388	94,00	PHG AX94	
1250	1219	48,00	PHG AX48	2450	2413	95,00	PHG AX95	
1280	1245	49,00	PHG AX49	2480	2438	96,00	PHG AX96	
1300	1270	50,00	PHG AX50	2500	2464	97,00	PHG AX97	
1330	1295	51,00	PHG AX51	2520	2489	98,00	PHG AX98	
1360	1321	52,00	PHG AX52	2570	2540	100,00	PHG AX100	
1380	1346	53,00	PHG AX53	2650	2616	103,00	PHG AX103	
1410	1372	54,00	PHG AX54	2680	2642	104,00	PHG AX104	
1430	1397	55,00	PHG AX55	2700	2667	105,00	PHG AX105	
1460	1422	56,00	PHG AX56	2830	2794	110,00	PHG AX110	
1480	1448	57,00	PHG AX57	2880	2845	112,00	PHG AX112	
1510	1473	58,00	PHG AX58	3030	2997	118,00	PHG AX118	
1530	1499	59,00	PHG AX59	3190	3150	124,00	PHG AX124	
1550	1524	60,00	PHG AX60	3390	3353	132,00	PHG AX132	

Nabídka obsahuje rovněž nestandardní délky.

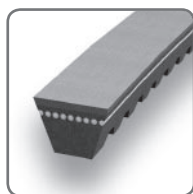

Ozubené klínové řemeny s klasickým průřezem řezané

X17/BX, X22/CX

- ▶ Řemeny
- ▶ Řetězy
- ▶ Spojky
- ▶ Pouzdra a náboje
- ▶ Řetězová kola
- ▶ Řemenice
- ▶ Inteligentní nástroje

Oddíl X17/BX ozubené řezané

Roztečná délka			Vnitřní délka			Označení	Roztečná délka			Vnitřní délka			Označení
mm	mm	in	mm	mm	in		mm	mm	in	mm	mm	in	
624	584	23,00	PHG BX23	1820	1778	70,00	PHG BX70						
675	635	25,00	PHG BX25	1850	1803	71,00	PHG BX71						
700	660	26,00	PHG BX26	1870	1829	72,00	PHG BX72						
750	711	28,00	PHG BX28	1900	1854	73,00	PHG BX73						
770	737	29,00	PHG BX29	1920	1880	74,00	PHG BX74						
800	762	30,00	PHG BX30	1950	1905	75,00	PHG BX75						
830	787	31,00	PHG BX31	1970	1930	76,00	PHG BX76						
860	813	32,00	PHG BX32	2000	1956	77,00	PHG BX77						
880	838	33,00	PHG BX33	2020	1981	78,00	PHG BX78						
910	864	34,00	PHG BX34	2050	2007	79,00	PHG BX79						
920	876	34,50	PHG BX34,5	2070	2032	80,00	PHG BX80						
930	889	35,00	PHG BX35	2100	2057	81,00	PHG BX81						
960	914	36,00	PHG BX36	2130	2083	82,00	PHG BX82						
980	940	37,00	PHG BX37	2150	2108	83,00	PHG BX83						
1000	965	38,00	PHG BX38	2180	2134	84,00	PHG BX84						
1030	991	39,00	PHG BX39	2200	2159	85,00	PHG BX85						
1060	1016	40,00	PHG BX40	2230	2184	86,00	PHG BX86						
1080	1041	41,00	PHG BX41	2250	2210	87,00	PHG BX87						
1100	1067	42,00	PHG BX42	2280	2235	88,00	PHG BX88						
1130	1092	43,00	PHG BX43	2300	2261	89,00	PHG BX89						
1160	1118	44,00	PHG BX44	2330	2286	90,00	PHG BX90						
1180	1143	45,00	PHG BX45	2350	2311	91,00	PHG BX91						
1195	1156	45,50	PHG BX45,5	2380	2337	92,00	PHG BX92						
1210	1168	46,00	PHG BX46	2400	2362	93,00	PHG BX93						
1225	1181	46,50	PHG BX46,5	2420	2388	94,00	PHG BX94						
1240	1194	47,00	PHG BX47	2450	2413	95,00	PHG BX95						
1260	1219	48,00	PHG BX48	2480	2438	96,00	PHG BX96						
1290	1245	49,00	PHG BX49	2500	2464	97,00	PHG BX97						
1310	1270	50,00	PHG BX50	2530	2489	98,00	PHG BX98						
1340	1295	51,00	PHG BX51	2560	2515	99,00	PHG BX99						
1370	1321	52,00	PHG BX52	2580	2540	100,00	PHG BX100						
1390	1346	53,00	PHG BX53	2660	2616	103,00	PHG BX103						
1410	1372	54,00	PHG BX54	2680	2642	104,00	PHG BX104						
1440	1397	55,00	PHG BX55	2700	2667	105,00	PHG BX105						
1460	1422	56,00	PHG BX56	2740	2692	106,00	PHG BX106						
1490	1448	57,00	PHG BX57	2790	2743	108,00	PHG BX108						
1510	1473	58,00	PHG BX58	2840	2794	110,00	PHG BX110						
1540	1499	59,00	PHG BX59	2890	2845	112,00	PHG BX112						
1560	1524	60,00	PHG BX60	2910	2870	113,00	PHG BX113						
1590	1549	61,00	PHG BX61	2960	2921	115,00	PHG BX115						
1620	1575	62,00	PHG BX62	2990	2946	116,00	PHG BX116						
1640	1600	63,00	PHG BX63	3040	2997	118,00	PHG BX118						
1670	1626	64,00	PHG BX64	3090	3048	120,00	PHG BX120						
1690	1651	65,00	PHG BX65	3165	3124	123,00	PHG BX123						
1720	1676	66,00	PHG BX66	3200	3150	124,00	PHG BX124						
1740	1702	67,00	PHG BX67	3240	3200	126,00	PHG BX126						
1760	1727	68,00	PHG BX68	3290	3251	128,00	PHG BX128						
1800	1753	69,00	PHG BX69	3400	3353	132,00	PHG BX132						

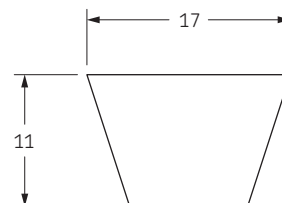

Oddíl X22/CX ozubené řezané

Roztečná délka			Vnitřní délka			Označení	Roztečná délka			Vnitřní délka			Označení
mm	mm	in	mm	mm	in		mm	mm	in	mm	mm	in	
1050	991	39,00	PHG CX39	2290	2235	88,00	PHG CX88						
1150	1092	43,00	PHG CX43	2340	2286	90,00	PHG CX90						
1300	1245	49,00	PHG CX49	2420	2362	93,00	PHG CX93						
1350	1295	51,00	PHG CX51	2490	2438	96,00	PHG CX96						
1370	1321	52,00	PHG CX52	2550	2489	98,00	PHG CX98						
1450	1397	55,00	PHG CX55	2600	2540	100,00	PHG CX100						
1560	1499	59,00	PHG CX59	2620	2565	101,00	PHG CX101						
1580	1524	60,00	PHG CX60	2720	2667	105,00	PHG CX105						
1630	1575	62,00	PHG CX62	2825	2769	109,00	PHG CX109						
1760	1702	67,00	PHG CX67	2850	2794	110,00	PHG CX110						
1780	1727	68,00	PHG CX68	2880	2819	111,00	PHG CX111						
1860	1803	71,00	PHG CX71	2900	2845	112,00	PHG CX112						
1880	1829	72,00	PHG CX72	2980	2921	115,00	PHG CX115						
1950	1905	75,00	PHG CX75	3050	2997	118,00	PHG CX118						
2040	1981	78,00	PHG CX78	3100	3048	120,00	PHG CX120						
2060	2007	79,00	PHG CX79	3210	3150	124,00	PHG CX124						
2110	2057	81,00	PHG CX81	3310	3251	128,00	PHG CX128						
2220	2159	85,00	PHG CX85	3410	3353	132,00	PHG CX132						

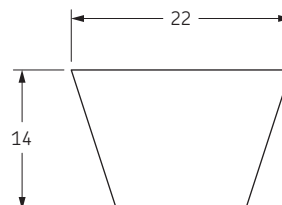

Nabídka obsahuje rovněž nestandardní délky.

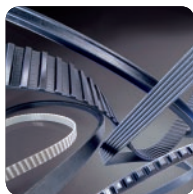

Ozubené úzké klínové řemeny řezané

3VX, 5VX

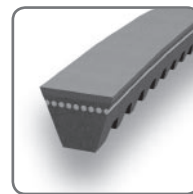

Oddíl 3VX/9NX ozubené řezané

Vnější délka		Označení	Vnější délka		Označení
mm	in		mm	in	
635	25,0	PHG 3VX250	1600	63,0	PHG 3VX630
673	26,5	PHG 3VX265	1702	67,0	PHG 3VX670
711	28,0	PHG 3VX280	1803	71,0	PHG 3VX710
762	30,0	PHG 3VX300	1905	75,0	PHG 3VX750
800	31,5	PHG 3VX315	2032	80,0	PHG 3VX800
851	33,5	PHG 3VX335	2159	85,0	PHG 3VX850
902	35,5	PHG 3VX355	2286	90,0	PHG 3VX900
953	37,5	PHG 3VX375	2413	95,0	PHG 3VX950
1016	40,0	PHG 3VX400	2540	100,0	PHG 3VX1000
1080	42,5	PHG 3VX425	2692	106,0	PHG 3VX1060
1143	45,0	PHG 3VX450	2845	112,0	PHG 3VX1120
1207	47,5	PHG 3VX475	2997	118,0	PHG 3VX1180
1270	50,0	PHG 3VX500	3175	125,0	PHG 3VX1250
1346	53,0	PHG 3VX530	3353	132,0	PHG 3VX1320
1422	56,0	PHG 3VX560	3556	140,0	PHG 3VX1400
1524	60,0	PHG 3VX600	3810	150,0	PHG 3VX1500

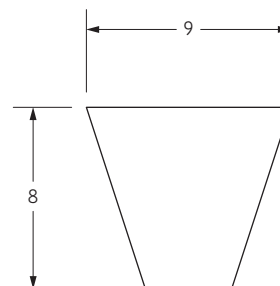

Oddíl 5VX/15NX ozubené řezané

Vnější délka		Označení	Vnější délka		Označení
mm	in		mm	in	
1270	50,0	PHG 5VX500	2692	106,0	PHG 5VX1060
1346	53,0	PHG 5VX530	2845	112,0	PHG 5VX1120
1422	56,0	PHG 5VX560	2997	118,0	PHG 5VX1180
1524	60,0	PHG 5VX600	3175	125,0	PHG 5VX1250
1600	63,0	PHG 5VX630	3353	132,0	PHG 5VX1320
1702	67,0	PHG 5VX670	3556	140,0	PHG 5VX1400
1803	71,0	PHG 5VX710	3810	150,0	PHG 5VX1500
1905	75,0	PHG 5VX750	4064	160,0	PHG 5VX1600
2032	80,0	PHG 5VX800	4318	170,0	PHG 5VX1700
2159	85,0	PHG 5VX850	4572	180,0	PHG 5VX1800
2286	90,0	PHG 5VX900	4826	190,0	PHG 5VX1900
2413	95,0	PHG 5VX950	5080	200,0	PHG 5VX2000
2540	100,0	PHG 5VX1000	-	-	-

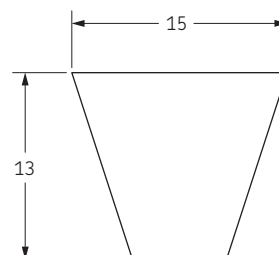

Nabídka obsahuje rovněž nestandardní délky.

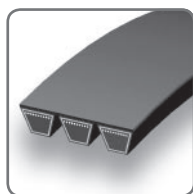

Násobné klínové řemeny s úzkým průřezem

SPB, SPC

- ▶ Řemeny
- ▶ Řetězy
- ▶ Spojky
- ▶ Pouzdra a náboje
- ▶ Řetězová kola
- ▶ Řemenice
- ▶ Inteligentní nástroje

Oddíl SPB oplétané

Typ řemenu	Roztečná délka	Označení	Typ řemenu	Roztečná délka	Označení
	mm			mm	
SPB2000	2000	PHG SPB2000X...	SPB4250	4250	PHG SPB4250X...
SPB2120	2120	PHG SPB2120X...	SPB4500	4500	PHG SPB4500X...
SPB2240	2240	PHG SPB2240X...	SPB4750	4750	PHG SPB4750X...
SPB2360	2360	PHG SPB2360X...	SPB5000	5000	PHG SPB5000X...
SPB2500	2500	PHG SPB2500X...	SPB5300	5300	PHG SPB5300X...
SPB2650	2650	PHG SPB2650X...	SPB5600	5600	PHG SPB5600X...
SPB2800	2800	PHG SPB2800X...	SPB6000	6000	PHG SPB6000X...
SPB3000	3000	PHG SPB3000X...	SPB6300	6300	PHG SPB6300X...
SPB3150	3150	PHG SPB3150X...	SPB6700	6700	PHG SPB6700X...
SPB3350	3350	PHG SPB3350X...	SPB7100	7100	PHG SPB7100X...
SPB3550	3550	PHG SPB3550X...	SPB7500	7500	PHG SPB7500X...
SPB3750	3750	PHG SPB3750X...	SPB8000	8000	PHG SPB8000X...
SPB4000	4000	PHG SPB4000X...	-	-	-

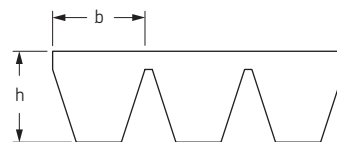

	SPB	SPC
b (mm)	16,5	22,0
h (mm)	15,6	22,6

Nabídka obsahuje rovněž nestandardní délky.

Oddíl SPC oplétané

Typ řemenu	Roztečná délka	Označení	Typ řemenu	Roztečná délka	Označení
	mm			mm	
SPC3000	3000	PHG SPC3000X...	SPC6300	6300	PHG SPC6300X...
SPC3150	3150	PHG SPC3150X...	SPC6700	6700	PHG SPC6700X...
SPC3350	3350	PHG SPC3350X...	SPC7100	7100	PHG SPC7100X...
SPC3550	3550	PHG SPC3550X...	SPC7500	7500	PHG SPC7500X...
SPC3750	3750	PHG SPC3750X...	SPC8000	8000	PHG SPC8000X...
SPC4000	4000	PHG SPC4000X...	SPC8500	8500	PHG SPC8500X...
SPC4250	4250	PHG SPC4250X...	SPC9000	9000	PHG SPC9000X...
SPC4500	4500	PHG SPC4500X...	SPC9500	9500	PHG SPC9500X...
SPC4750	4750	PHG SPC4750X...	SPC10000	10000	PHG SPC10000X...
SPC5000	5000	PHG SPC5000X...	SPC10600	10600	PHG SPC10600X...
SPC5300	5300	PHG SPC5300X...	SPC11200	11200	PHG SPC11200X...
SPC5600	5600	PHG SPC5600X...	SPC11800	11800	PHG SPC11800X...
SPC6000	6000	PHG SPC6000X...	SPC12500	12500	PHG SPC12500X...

Pro úplné označení přidejte číslici označující počet řemenů. Například PHG SPC8000X4.



Násobné klínové řemeny s klasickým průřezem

A, B, C, D



Oddíl 13/A oplétané

Typ řemenu	Roztečná délka	Vnitřní délka	Označení	Typ řemenu	Roztečná délka	Vnitřní délka	Označení
	mm	in			mm	in	
A47	1230	47,0	PHG A47X...	A98	2520	98,0	PHG A98X...
A51	1330	51,0	PHG A51X...	A100	2570	100,0	PHG A100X...
A56	1460	56,0	PHG A56X...	A104	2680	104,0	PHG A104X...
A57	1480	57,0	PHG A57X...	A112	2880	112,0	PHG A112X...
A59	1530	59,0	PHG A59X...	A120	3080	120,0	PHG A120X...
A64	1660	64,0	PHG A64X...	A128	3290	128,0	PHG A128X...
A67	1740	67,0	PHG A67X...	A144	3690	144,0	PHG A144X...
A71	1840	71,0	PHG A71X...	A158	4043	158,0	PHG A158X...
A75	1940	75,0	PHG A75X...	A167	4270	167,0	PHG A167X...
A79	2050	79,0	PHG A79X...	A187	4780	187,0	PHG A187X...
A88	2270	88,0	PHG A88X...	-	-	-	-

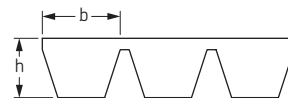

	A	B	C	D
b (mm)	13,0	17,0	22,0	32,0
h (mm)	9,9	13,0	16,2	22,4

Nabídka obsahuje rovněž nestandardní délky.

Oddíl 17/B oplétané

Typ řemenu	Roztečná délka	Vnitřní délka	Označení	Typ řemenu	Roztečná délka	Vnitřní délka	Označení
	mm	in			mm	in	
B47	1240	47,0	PHG B47X...	B102	2630	102,0	PHG B102X...
B51	1340	51,0	PHG B51X...	B106	2740	106,0	PHG B106X...
B55	1440	55,0	PHG B55X...	B112	2890	112,0	PHG B112X...
B59	1540	59,0	PHG B59X...	B118	3040	118,0	PHG B118X...
B61	1590	61,0	PHG B61X...	B120	3090	120,0	PHG B120X...
B63	1640	63,0	PHG B63X...	B128	3290	128,0	PHG B128X...
B64	1670	64,0	PHG B64X...	B132	3400	132,0	PHG B132X...
B67	1740	67,0	PHG B67X...	B140	3600	140,0	PHG B140X...
B71	1850	71,0	PHG B71X...	B146	3750	146,0	PHG B146X...
B73	1900	73,0	PHG B73X...	B148	3800	148,0	PHG B148X...
B75	1950	75,0	PHG B75X...	B158	4060	158,0	PHG B158X...
B79	2050	79,0	PHG B79X...	B167	4280	167,0	PHG B167X...
B83	2150	83,0	PHG B83X...	B177	4540	177,0	PHG B177X...
B88	2280	88,0	PHG B88X...	B187	4800	187,0	PHG B187X...
B91	2350	91,0	PHG B91X...	B197	5044	197,0	PHG B197X...
B94,5	2435	94,5	PHG B94,5X...	B208	5340	208,0	PHG B208X...
B98	2530	98,0	PHG B98X...	B220	5630	220,0	PHG B220X...

Oddíl 22/C oplétané

Typ řemenu	Roztečná délka	Vnitřní délka	Označení	Typ řemenu	Roztečná délka	Vnitřní délka	Označení
	mm	in			mm	in	
C90	2340	90,0	PHG C90X...	C167	4300	167,0	PHG C167X...
C98	2550	98,0	PHG C98X...	C177	4560	177,0	PHG C177X...
C108	2800	108,0	PHG C108X...	C187	4810	187,0	PHG C187X...
C120	3100	120,0	PHG C120X...	C197	5060	197,0	PHG C197X...
C128	3310	128,0	PHG C128X...	C208	5340	208,0	PHG C208X...
C140	3610	140,0	PHG C140X...	C220	5640	220,0	PHG C220X...
C146	3760	146,0	PHG C146X...	C236	6050	236,0	PHG C236X...
C151	3895	151,0	PHG C151X...	C248	6360	248,0	PHG C248X...

Oddíl 32/D oplétané

Typ řemenu	Roztečná délka	Vnitřní délka	Označení	Typ řemenu	Roztečná délka	Vnitřní délka	Označení
	mm	in			mm	in	
D98	2560	98	PHG D98X...	D255	6560	255	PHG D255X...
D110	2870	110	PHG D110X...	D270	6940	270	PHG D270X...
D120	3130	120	PHG D120X...	D285	7320	285	PHG D285X...
D128	3330	128	PHG D128X...	D300	7700	300	PHG D300X...
D144	3730	144	PHG D144X...	D315	8080	315	PHG D315X...
D158	4080	158	PHG D158X...	D330	8460	330	PHG D330X...
D162	4190	162	PHG D162X...	D345	8840	345	PHG D345X...
D173	4470	173	PHG D173X...	D360	9220	360	PHG D360X...
D180	4650	180	PHG D180X...	D390	9980	390	PHG D390X...
D195	5030	195	PHG D195X...	D420	10740	420	PHG D420X...
D210	5400	210	PHG D210X...	D450	11505	450	PHG D450X...
D225	5790	225	PHG D225X...	D480	12270	480	PHG D480X...
D240	6170	240	PHG D240X...	D540	13790	540	PHG D540X...

Pro úplné označení přidejte číslici označující počet řemenů. Například PHG D360X6.



Násobné úzké klínové řemeny

3V, 5V, 8V

- ▶ Řemeny
- ▶ Řetězy
- ▶ Spojky
- ▶ Pouzdra a náboje
- ▶ Řetězová kola
- ▶ Řemenice
- ▶ Inteligentní nástroje

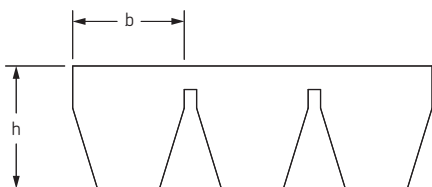

	3V	5V	8V
b (mm)	9,0	15,0	25,0
h (mm)	9,9	15,1	25,5

Nabídka obsahuje rovněž nestandardní délky.

Oddíl 3V/9J oplétané

Typ řemenu	Vnější délka		Označení	Typ řemenu	Vnější délka		Označení
	mm	in			mm	in	
3V500	1270	50,0	PHG 3V500X...	3V900	2286	90,0	PHG 3V900X...
3V530	1346	53,0	PHG 3V530X...	3V950	2413	95,0	PHG 3V950X...
3V560	1422	56,0	PHG 3V560X...	3V1000	2540	100,0	PHG 3V1000X...
3V600	1524	60,0	PHG 3V600X...	3V1060	2692	106,0	PHG 3V1060X...
3V630	1600	63,0	PHG 3V630X...	3V1120	2845	112,0	PHG 3V1120X...
3V670	1702	67,0	PHG 3V670X...	3V1180	2997	118,0	PHG 3V1180X...
3V710	1803	71,0	PHG 3V710X...	3V1250	3175	125,0	PHG 3V1250X...
3V750	1905	75,0	PHG 3V750X...	3V1320	3353	132,0	PHG 3V1320X...
3V800	2032	80,0	PHG 3V800X...	3V1400	3556	140,0	PHG 3V1400X...
3V850	2159	85,0	PHG 3V850X...	-	-	-	-

Oddíl 5V/15J oplétané

Typ řemenu	Vnější délka		Označení	Typ řemenu	Vnější délka		Označení
	mm	in			mm	in	
5V560	1422	56,0	PHG 5V560X...	5V1400	3556	140,0	PHG 5V1400X...
5V600	1524	60,0	PHG 5V600X...	5V1500	3810	150,0	PHG 5V1500X...
5V630	1600	63,0	PHG 5V630X...	5V1600	4064	160,0	PHG 5V1600X...
5V670	1702	67,0	PHG 5V670X...	5V1700	4318	170,0	PHG 5V1700X...
5V710	1803	71,0	PHG 5V710X...	5V1800	4572	180,0	PHG 5V1800X...
5V750	1905	75,0	PHG 5V750X...	5V1900	4826	190,0	PHG 5V1900X...
5V800	2032	80,0	PHG 5V800X...	5V2000	5080	200,0	PHG 5V2000X...
5V850	2159	85,0	PHG 5V850X...	5V2120	5385	212,0	PHG 5V2120X...
5V900	2286	90,0	PHG 5V900X...	5V2240	5690	224,0	PHG 5V2240X...
5V950	2413	95,0	PHG 5V950X...	5V2360	5994	236,0	PHG 5V2360X...
5V1000	2540	100,0	PHG 5V1000X...	5V2500	6350	250,0	PHG 5V2500X...
5V1060	2692	106,0	PHG 5V1060X...	5V2650	6731	265,0	PHG 5V2650X...
5V1120	2845	112,0	PHG 5V1120X...	5V2800	7112	280,0	PHG 5V2800X...
5V1180	2997	118,0	PHG 5V1180X...	5V3000	7620	300,0	PHG 5V3000X...
5V1250	3175	125,0	PHG 5V1250X...	5V3150	8001	315,0	PHG 5V3150X...
5V1320	3353	132,0	PHG 5V1320X...	5V3350	8509	335,0	PHG 5V3350X...

Oddíl 8V/25J oplétané

Typ řemenu	Vnější délka		Označení	Typ řemenu	Vnější délka		Označení
	mm	in			mm	in	
8V1000	2540	100,0	PHG 8V1000X...	8V2240	5690	224,0	PHG 8V2240X...
8V1060	2692	106,0	PHG 8V1060X...	8V2360	5994	236,0	PHG 8V2360X...
8V1120	2845	112,0	PHG 8V1120X...	8V2500	6350	250,0	PHG 8V2500X...
8V1180	2997	118,0	PHG 8V1180X...	8V2650	6731	265,0	PHG 8V2650X...
8V1250	3175	125,0	PHG 8V1250X...	8V2800	7112	280,0	PHG 8V2800X...
8V1320	3353	132,0	PHG 8V1320X...	8V3000	7620	300,0	PHG 8V3000X...
8V1400	3556	140,0	PHG 8V1400X...	8V3150	8001	315,0	PHG 8V3150X...
8V1500	3810	150,0	PHG 8V1500X...	8V3350	8509	335,0	PHG 8V3350X...
8V1600	4064	160,0	PHG 8V1600X...	8V3500	9017	355,0	PHG 8V3500X...
8V1700	4318	170,0	PHG 8V1700X...	8V3750	9525	375,0	PHG 8V3750X...
8V1800	4572	180,0	PHG 8V1800X...	8V4000	10160	400,0	PHG 8V4000X...
8V1900	4826	190,0	PHG 8V1900X...	8V4250	10795	425,0	PHG 8V4250X...
8V2000	5080	200,0	PHG 8V2000X...	8V4500	11430	450,0	PHG 8V4500X...
8V2120	5385	212,0	PHG 8V2120X...	8V4750	12065	475,0	PHG 8V4750X...

Pro úplné označení přidejte číslici označující počet řemenů. Například PHG 8V3350X3.



Oboustranné klínové řemeny s klasickým průřezem

AA, BB, CC

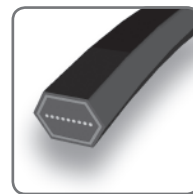

Oddíl AA/HAA oboustranný klínový řemen

Roztečná délka	Vnitřní délka	Označení	Roztečná délka	Vnitřní délka	Označení
mm	in		mm	in	
2000	77	PHG AA77	2667	103	PHG AA103
2032	78	PHG AA78	2800	108	PHG AA108
2370	91	PHG AA91	3300	128	PHG AA128
2500	96	PHG AA96	3920	152	PHG AA152
2650	102	PHG AA102	-	-	-

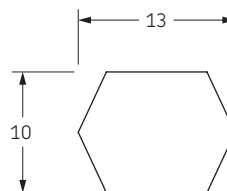

Oddíl BB/HBB oboustranný klínový řemen

Roztečná délka	Vnitřní délka	Označení	Roztečná délka	Vnitřní délka	Označení
mm	in		mm	in	
1980	75	PHG BB75	3250	125	PHG BB125
2180	83	PHG BB83	3280	126	PHG BB126
2300	88	PHG BB88	3325	128	PHG BB128
2370	90	PHG BB90	3390	131	PHG BB131
2500	95	PHG BB95	3450	133	PHG BB133
2540	97	PHG BB97	3500	135	PHG BB135
2600	99	PHG BB99	3550	137	PHG BB137
2650	101	PHG BB101	3730	144	PHG BB144
2740	105	PHG BB105	3750	145	PHG BB145
2800	107	PHG BB107	4010	155	PHG BB155
2850	109	PHG BB109	4040	156	PHG BB156
2920	112	PHG BB112	4200	162	PHG BB162
3000	115	PHG BB115	4470	173	PHG BB173
3030	116	PHG BB116	4500	174	PHG BB174
3150	121	PHG BB121	4750	184	PHG BB184

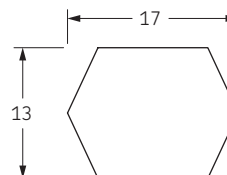

Oddíl CC/HCC oboustranný klínový řemen

Roztečná délka	Vnitřní délka	Označení	Roztečná délka	Vnitřní délka	Označení
mm	in		mm	in	
2280	86	PHG CC86	4216	162	PHG CC162
2500	94	PHG CC94	4300	165	PHG CC165
2800	106	PHG CC106	4500	173	PHG CC173
3200	122	PHG CC122	5000	193	PHG CC193
3310	126	PHG CC126	5300	204	PHG CC204
3765	144	PHG CC144	5340	206	PHG CC206
4000	153	PHG CC153	5750	224	PHG CC224

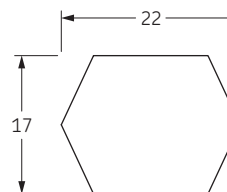

Nabídka obsahuje rovněž nestandardní délky.

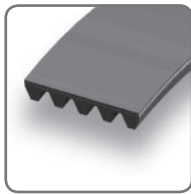

Víceklínové řemeny

PJ

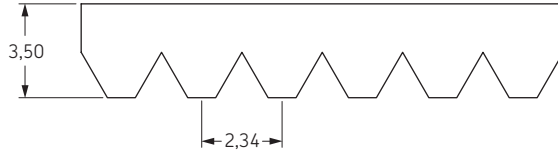

- ▶ Řemeny
- ▶ Řetězy
- ▶ Spojky
- ▶ Pouzdra a náboje
- ▶ Řetězová kola
- ▶ Řemenice
- ▶ Inteligentní nástroje

Roztečná délka		Označení	Roztečná délka		Označení
mm	in		mm	in	
540	21,3	PHG ...PJ540	1310	51,6	PHG ...PJ1310
550	21,7	PHG ...PJ550	1320	52,0	PHG ...PJ1320
580	22,8	PHG ...PJ580	1330	52,4	PHG ...PJ1330
610	24,0	PHG ...PJ610	1355	53,4	PHG ...PJ1355
660	26,0	PHG ...PJ660	1370	53,9	PHG ...PJ1370
710	28,0	PHG ...PJ710	1390	54,7	PHG ...PJ1390
720	28,3	PHG ...PJ720	1420	55,9	PHG ...PJ1420
760	29,9	PHG ...PJ760	1430	56,3	PHG ...PJ1430
810	31,9	PHG ...PJ810	1475	58,1	PHG ...PJ1475
830	32,7	PHG ...PJ830	1540	60,6	PHG ...PJ1540
860	33,9	PHG ...PJ860	1600	63,0	PHG ...PJ1600
910	35,8	PHG ...PJ910	1650	65,0	PHG ...PJ1650
955	37,6	PHG ...PJ955	1660	65,4	PHG ...PJ1660
965	38,0	PHG ...PJ965	1750	68,9	PHG ...PJ1750
1010	39,8	PHG ...PJ1010	1780	70,0	PHG ...PJ1780
1090	42,9	PHG ...PJ1090	1850	72,8	PHG ...PJ1850
1105	43,5	PHG ...PJ1105	1895	74,6	PHG ...PJ1895
1110	43,7	PHG ...PJ1110	1910	75,2	PHG ...PJ1910
1120	44,1	PHG ...PJ1120	1915	75,4	PHG ...PJ1915
1130	44,5	PHG ...PJ1130	1930	76,0	PHG ...PJ1930
1150	45,3	PHG ...PJ1150	1950	76,8	PHG ...PJ1950
1160	45,7	PHG ...PJ1160	1965	77,4	PHG ...PJ1965
1190	46,9	PHG ...PJ1190	1980	78,0	PHG ...PJ1980
1200	47,3	PHG ...PJ1200	1990	78,3	PHG ...PJ1990
1220	48,0	PHG ...PJ1220	2080	81,9	PHG ...PJ2080
1240	48,8	PHG ...PJ1240	2100	82,7	PHG ...PJ2100
1270	50,0	PHG ...PJ1270	2155	84,8	PHG ...PJ2155
1285	50,6	PHG ...PJ1285	2210	87,0	PHG ...PJ2210
1300	51,2	PHG ...PJ1300	2330	91,7	PHG ...PJ2330
1305	51,4	PHG ...PJ1305	2480	97,6	PHG ...PJ2480

Nabídka obsahuje rovněž nestandardní délky.

K základnímu označení doplňte počet žeber, např. PHG 4PJ1320, aby označení bylo úplné.

Víceklínové řemeny

PK

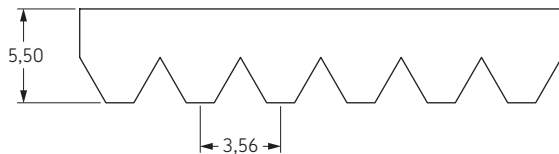
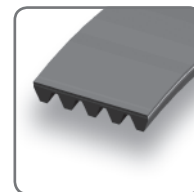

Roztečná délka		Označení	Roztečná délka		Označení
mm	in		mm	in	
540	21,3	PHG ...PK540	1200	47,3	PHG ...PK1200
575	22,6	PHG ...PK575	1220	48,0	PHG ...PK1220
600	23,6	PHG ...PK600	1240	48,8	PHG ...PK1240
635	25,0	PHG ...PK635	1260	49,6	PHG ...PK1260
650	25,6	PHG ...PK650	1280	50,4	PHG ...PK1280
665	26,2	PHG ...PK665	1300	51,2	PHG ...PK1300
690	27,2	PHG ...PK690	1320	52,0	PHG ...PK1320
710	28,0	PHG ...PK710	1340	52,8	PHG ...PK1340
740	29,1	PHG ...PK740	1360	53,5	PHG ...PK1360
760	29,9	PHG ...PK760	1380	54,3	PHG ...PK1380
785	30,9	PHG ...PK785	1400	55,1	PHG ...PK1400
790	31,1	PHG ...PK790	1420	55,9	PHG ...PK1420
800	31,5	PHG ...PK800	1440	56,7	PHG ...PK1440
820	32,3	PHG ...PK820	1460	57,5	PHG ...PK1460
840	33,1	PHG ...PK840	1480	58,3	PHG ...PK1480
850	33,5	PHG ...PK850	1500	59,1	PHG ...PK1500
865	34,1	PHG ...PK865	1520	59,8	PHG ...PK1520
870	34,3	PHG ...PK870	1540	60,6	PHG ...PK1540
885	34,8	PHG ...PK885	1560	61,4	PHG ...PK1560
890	35,0	PHG ...PK890	1580	62,2	PHG ...PK1580
900	35,4	PHG ...PK900	1600	63,0	PHG ...PK1600
910	35,8	PHG ...PK910	1620	63,8	PHG ...PK1620
925	36,4	PHG ...PK925	1640	64,6	PHG ...PK1640
940	37,0	PHG ...PK940	1660	65,4	PHG ...PK1660
945	37,2	PHG ...PK945	1680	66,1	PHG ...PK1680
950	37,4	PHG ...PK950	1690	66,5	PHG ...PK1690
960	37,8	PHG ...PK960	1710	67,3	PHG ...PK1710
970	38,2	PHG ...PK970	1720	67,7	PHG ...PK1720
980	38,6	PHG ...PK980	1770	69,7	PHG ...PK1770
990	39,0	PHG ...PK990	1780	70,1	PHG ...PK1780
1000	39,4	PHG ...PK1000	1800	70,9	PHG ...PK1800
1010	39,8	PHG ...PK1010	1830	72,0	PHG ...PK1830
1015	40,0	PHG ...PK1015	1865	73,4	PHG ...PK1865
1020	40,2	PHG ...PK1020	1880	74,0	PHG ...PK1880
1040	40,9	PHG ...PK1040	1900	74,8	PHG ...PK1900
1050	41,3	PHG ...PK1050	1950	76,8	PHG ...PK1950
1060	41,7	PHG ...PK1060	1980	78,0	PHG ...PK1980
1075	42,3	PHG ...PK1075	2020	79,5	PHG ...PK2020
1080	42,5	PHG ...PK1080	2080	81,9	PHG ...PK2080
1090	42,9	PHG ...PK1090	2100	82,7	PHG ...PK2100
1100	43,3	PHG ...PK1100	2110	83,1	PHG ...PK2110
1120	44,1	PHG ...PK1120	2130	83,9	PHG ...PK2130
1130	44,5	PHG ...PK1130	2210	87,0	PHG ...PK2210
1140	44,9	PHG ...PK1140	2230	87,8	PHG ...PK2230
1150	45,3	PHG ...PK1150	2250	88,6	PHG ...PK2250
1160	45,7	PHG ...PK1160	2300	90,6	PHG ...PK2300
1170	46,1	PHG ...PK1170	2330	91,7	PHG ...PK2330
1180	46,5	PHG ...PK1180	2420	95,3	PHG ...PK2420
1190	46,9	PHG ...PK1190	-	-	-

Nabídka obsahuje rovněž nestandardní délky.

K základnímu označení doplňte počet žeber, např. PHG 4PK1600, aby označení bylo úplné.

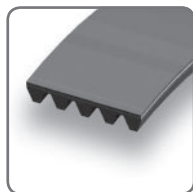

Víceklínové řemeny

PL, PM

- ▶ Řemeny
- ▶ Řetězy
- ▶ Spojky
- ▶ Pouzdra a náboje
- ▶ Řetězová kola
- ▶ Řemenice
- ▶ Inteligentní nástroje

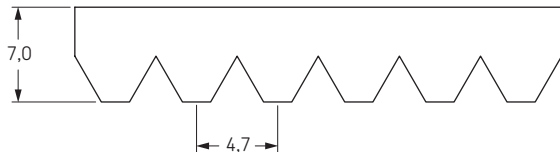

Roztečná délka		Označení	Roztečná délka		Označení
mm	in		mm	in	
1075	42,5	PHG ...PL1075	2197	86,5	PHG ...PL2197
1270	50,0	PHG ...PL1270	2235	88,0	PHG ...PL2235
1333	52,5	PHG ...PL1333	2324	91,5	PHG ...PL2324
1371	54,0	PHG ...PL1371	2362	93,0	PHG ...PL2362
1397	55,0	PHG ...PL1397	2476	97,5	PHG ...PL2476
1422	56,0	PHG ...PL1422	2515	99,0	PHG ...PL2515
1562	61,5	PHG ...PL1562	2705	106,5	PHG ...PL2705
1613	63,5	PHG ...PL1613	2743	108,0	PHG ...PL2743
1664	65,5	PHG ...PL1664	2845	112,0	PHG ...PL2845
1715	67,5	PHG ...PL1715	2895	114,0	PHG ...PL2895
1764	69,5	PHG ...PL1764	2921	115,0	PHG ...PL2921
1803	71,0	PHG ...PL1803	2997	116,0	PHG ...PL2997
1841	72,5	PHG ...PL1841	3086	121,5	PHG ...PL3086
1943	76,5	PHG ...PL1943	3124	123,0	PHG ...PL3124
1981	78,0	PHG ...PL1981	3289	129,5	PHG ...PL3289
2020	79,5	PHG ...PL2020	3327	131,0	PHG ...PL3327
2070	81,5	PHG ...PL2070	3492	137,5	PHG ...PL3492
2096	82,5	PHG ...PL2096	3696	145,5	PHG ...PL3696
2134	84,0	PHG ...PL2134	4051	159,5	PHG ...PL4051

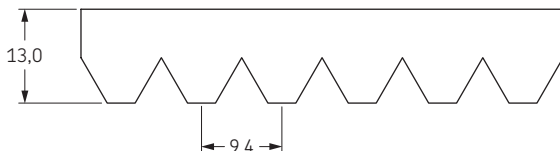

Roztečná délka		Označení	Roztečná délka		Označení
mm	in		mm	in	
2693	106,0	PHG ...PM2693	4191	165,0	PHG ...PM4191
2832	111,5	PHG ...PM2832	4470	176,0	PHG ...PM4470
2921	115,0	PHG ...PM2921	4648	183,0	PHG ...PM4648
3010	118,5	PHG ...PM3010	5029	198,0	PHG ...PM5029
3124	123,0	PHG ...PM3124	5410	213,0	PHG ...PM5410
3327	131,0	PHG ...PM3327	6121	241,0	PHG ...PM6121
3531	139,0	PHG ...PM3531	6883	271,0	PHG ...PM6883
3734	147,0	PHG ...PM3734	7646	301,0	PHG ...PM7646
4089	161,0	PHG ...PM4089	8408	331,0	PHG ...PM8408

Nabídka obsahuje rovněž nestandardní délky.

K základnímu označení doplňte počet žebër, např. PHG 6PM5410, aby označení bylo úplné.



Synchronní ozubené řemeny

MXL

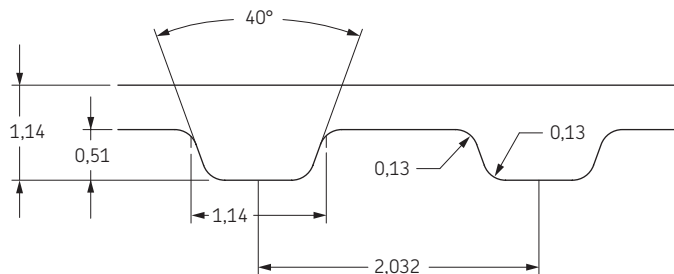

Typ řemenu	Počet zubů	Rozečná délka		Označení	Typ řemenu	Počet zubů	Rozečná délka		Označení	Typ řemenu	Počet zubů	Rozečná délka		Označení
		in	mm				in	mm				in	mm	
21-MXL	26	2,08	52,83	PHG 21-MXL-...	85-MXL	106	8,48	215,39	PHG 85-MXL-...	180-MXL	225	18,00	457,20	PHG 180-MXL-...
22-MXL	27	2,16	54,86	PHG 22-MXL-...	86-MXL	108	8,64	219,46	PHG 86-MXL-...	182-MXL	228	18,20	462,28	PHG 182-MXL-...
26-MXL	33	2,64	67,06	PHG 26-MXL-...	87-MXL	109	8,72	221,49	PHG 87-MXL-...	185-MXL	232	18,56	471,42	PHG 185-MXL-...
28-MXL	35	2,80	71,12	PHG 28-MXL-...	88-MXL	110	8,80	223,52	PHG 88-MXL-...	189-MXL	236	18,88	479,55	PHG 189-MXL-...
32-MXL	40	3,20	81,28	PHG 32-MXL-...	89-MXL	112	8,96	227,58	PHG 89-MXL-...	191-MXL	239	19,12	485,65	PHG 191-MXL-...
34-MXL	43	3,44	87,38	PHG 34-MXL-...	90-MXL	113	9,04	229,62	PHG 90-MXL-...	192-MXL	240	19,20	487,68	PHG 192-MXL-...
36-MXL	45	3,60	91,44	PHG 36-MXL-...	91-MXL	114	9,12	231,65	PHG 91-MXL-...	199-MXL	249	19,92	505,97	PHG 199-MXL-...
39-MXL	49	3,92	99,57	PHG 39-MXL-...	92-MXL	115	9,20	233,68	PHG 92-MXL-...	200-MXL	250	20,00	508,00	PHG 200-MXL-...
40-MXL	50	4,00	101,60	PHG 40-MXL-...	93-MXL	116	9,28	235,71	PHG 93-MXL-...	205-MXL	256	20,48	520,19	PHG 205-MXL-...
41-MXL	51	4,08	103,63	PHG 41-MXL-...	94-MXL	118	9,44	239,78	PHG 94-MXL-...	212-MXL	265	21,20	538,48	PHG 212-MXL-...
41,6-MXL	52	4,16	105,66	PHG 41,6-MXL-...	96-MXL	120	9,60	243,84	PHG 96-MXL-...	218-MXL	273	21,84	554,74	PHG 218-MXL-...
42-MXL	53	4,24	107,70	PHG 42-MXL-...	97,6-MXL	122	9,76	247,90	PHG 97,6-MXL-...	221-MXL	276	22,08	560,83	PHG 221-MXL-...
43-MXL	54	4,32	109,73	PHG 43-MXL-...	98-MXL	123	9,84	249,94	PHG 98-MXL-...	224-MXL	280	22,40	568,96	PHG 224-MXL-...
44-MXL	55	4,40	111,76	PHG 44-MXL-...	100-MXL	125	10,00	254,00	PHG 100-MXL-...	232-MXL	290	23,20	589,28	PHG 232-MXL-...
45-MXL	56	4,48	113,79	PHG 45-MXL-...	101-MXL	126	10,08	256,03	PHG 101-MXL-...	236-MXL	295	23,60	599,44	PHG 236-MXL-...
46-MXL	58	4,64	117,86	PHG 46-MXL-...	106-MXL	132	10,56	268,22	PHG 106-MXL-...	238-MXL	298	23,84	605,54	PHG 238-MXL-...
47-MXL	59	4,72	119,89	PHG 47-MXL-...	106,4-MXL	133	10,64	270,26	PHG 106,4-MXL-...	240-MXL	300	24,00	609,60	PHG 240-MXL-...
48-MXL	60	4,80	121,92	PHG 48-MXL-...	108-MXL	135	10,80	274,32	PHG 108-MXL-...	244-MXL	305	24,40	619,76	PHG 244-MXL-...
49-MXL	61	4,88	123,95	PHG 49-MXL-...	109-MXL	136	10,88	276,35	PHG 109-MXL-...	250-MXL	312	24,96	633,98	PHG 250-MXL-...
49,6-MXL	62	4,96	125,98	PHG 49,6-MXL-...	109,6-MXL	137	10,96	278,38	PHG 109,6-MXL-...	254-MXL	318	25,44	646,18	PHG 254-MXL-...
50-MXL	63	5,04	128,02	PHG 50-MXL-...	110-MXL	138	11,04	280,42	PHG 110-MXL-...	256-MXL	320	25,60	650,24	PHG 256-MXL-...
51-MXL	64	5,12	130,05	PHG 51-MXL-...	111-MXL	139	11,12	282,45	PHG 111-MXL-...	262-MXL	328	26,24	666,50	PHG 262-MXL-...
52-MXL	65	5,20	132,08	PHG 52-MXL-...	112-MXL	140	11,20	284,48	PHG 112-MXL-...	269-MXL	336	26,88	682,75	PHG 269-MXL-...
53-MXL	66	5,28	134,11	PHG 53-MXL-...	113-MXL	142	11,36	288,54	PHG 113-MXL-...	278-MXL	347	27,76	705,10	PHG 278-MXL-...
53,6-MXL	67	5,36	136,14	PHG 53,6-MXL-...	115-MXL	144	11,52	292,61	PHG 115-MXL-...	290-MXL	362	28,96	735,58	PHG 290-MXL-...
54-MXL	68	5,44	138,18	PHG 54-MXL-...	116-MXL	145	11,60	294,64	PHG 116-MXL-...	302-MXL	378	30,24	768,10	PHG 302-MXL-...
56-MXL	70	5,60	142,24	PHG 56-MXL-...	118-MXL	148	11,84	300,74	PHG 118-MXL-...	320-MXL	400	32,00	812,80	PHG 320-MXL-...
57-MXL	71	5,68	144,27	PHG 57-MXL-...	119-MXL	149	11,92	302,77	PHG 119-MXL-...	326-MXL	408	32,64	829,06	PHG 326-MXL-...
58-MXL	72	5,76	146,30	PHG 58-MXL-...	120-MXL	150	12,00	304,80	PHG 120-MXL-...	358-MXL	448	35,84	910,34	PHG 358-MXL-...
58,4-MXL	73	5,84	148,34	PHG 58,4-MXL-...	121-MXL	152	12,16	308,86	PHG 121-MXL-...	370-MXL	463	37,04	940,82	PHG 370-MXL-...
60-MXL	75	6,00	152,40	PHG 60-MXL-...	122-MXL	153	12,24	310,90	PHG 122-MXL-...	378-MXL	472	37,76	959,10	PHG 378-MXL-...
61-MXL	76	6,08	154,43	PHG 61-MXL-...	123-MXL	154	12,32	312,93	PHG 123-MXL-...	403-MXL	504	40,32	1024,13	PHG 403-MXL-...
61,6-MXL	77	6,16	156,46	PHG 61,6-MXL-...	124-MXL	155	12,40	314,96	PHG 124-MXL-...	418-MXL	522	41,76	1060,70	PHG 418-MXL-...
62-MXL	78	6,24	158,50	PHG 62-MXL-...	125-MXL	156	12,48	316,99	PHG 125-MXL-...	425-MXL	531	42,48	1078,99	PHG 425-MXL-...
63-MXL	79	6,32	160,53	PHG 63-MXL-...	126-MXL	158	12,64	321,06	PHG 126-MXL-...	437-MXL	546	43,68	1109,47	PHG 437-MXL-...
64-MXL	80	6,40	162,56	PHG 64-MXL-...	128-MXL	160	12,80	325,12	PHG 128-MXL-...	438-MXL	548	43,84	1113,54	PHG 438-MXL-...
65-MXL	82	6,56	166,62	PHG 65-MXL-...	130-MXL	162	12,96	329,18	PHG 130-MXL-...	456-MXL	570	45,60	1158,24	PHG 456-MXL-...
66-MXL	83	6,64	168,66	PHG 66-MXL-...	132-MXL	165	13,20	335,28	PHG 132-MXL-...	466-MXL	583	46,64	1184,66	PHG 466-MXL-...
68-MXL	85	6,80	172,72	PHG 68-MXL-...	134-MXL	168	13,44	341,38	PHG 134-MXL-...	480-MXL	600	48,00	1219,20	PHG 480-MXL-...
69-MXL	87	6,96	176,78	PHG 69-MXL-...	136-MXL	170	13,60	345,44	PHG 136-MXL-...	518-MXL	648	51,84	1316,74	PHG 518-MXL-...
70-MXL	88	7,04	178,82	PHG 70-MXL-...	140-MXL	175	14,00	355,60	PHG 140-MXL-...	544-MXL	680	54,40	1381,76	PHG 544-MXL-...
71-MXL	89	7,12	180,85	PHG 71-MXL-...	144-MXL	180	14,40	365,76	PHG 144-MXL-...	600-MXL	750	60,00	1524,00	PHG 600-MXL-...
72-MXL	90	7,20	182,88	PHG 72-MXL-...	147-MXL	184	14,72	373,89	PHG 147-MXL-...	608-MXL	760	60,80	1544,32	PHG 608-MXL-...
73-MXL	92	7,36	186,94	PHG 73-MXL-...	152-MXL	190	15,20	386,08	PHG 152-MXL-...	640-MXL	800	64,00	1625,60	PHG 640-MXL-...
75-MXL	94	7,52	191,01	PHG 75-MXL-...	154-MXL	192	15,36	390,14	PHG 154-MXL-...	764-MXL	955	76,40	1940,56	PHG 764-MXL-...
76-MXL	95	7,60	193,04	PHG 76-MXL-...	155-MXL	194	15,52	394,21	PHG 155-MXL-...	765-MXL	957	76,56	1944,62	PHG 765-MXL-...
77-MXL	97	7,76	197,10	PHG 77-MXL-...	156-MXL	195	15,60	396,24	PHG 156-MXL-...	810-MXL	1012	80,96	2056,38	PHG 810-MXL-...
78-MXL	98	7,84	199,14	PHG 78-MXL-...	160-MXL	200	16,00	406,40	PHG 160-MXL-...	824-MXL	1030	82,40	2092,96	PHG 824-MXL-...
80-MXL	100	8,00	203,20	PHG 80-MXL-...	165-MXL	206	16,48	418,59	PHG 165-MXL-...	848-MXL	1060	84,80	2153,92	PHG 848-MXL-...
81-MXL	102	8,16	207,26	PHG 81-MXL-...	168-MXL	210	16,80	426,72	PHG 168-MXL-...	910-MXL	1137	90,96	2310,38	PHG 910-MXL-...
82-MXL	103	8,24	209,30	PHG 82-MXL-...	169-MXL	212	16,96	430,78	PHG 169-MXL-...	1000-MXL	1250	100,00	2540,00	PHG 1000-MXL-...
84-MXL	105	8,40	213,36	PHG 84-MXL-...	177-MXL	221	17,68	449,07	PHG 177-MXL-...					

K základnímu označení doplňte tři číslice, které vyjadřují šířku pásu v setinách palce, např. 025 pro šířku 1/4", popř. 037 pro šířku 3/8", aby označení bylo úplné.

Nabídka obsahuje rovněž nestandardní délky.

Řemenové rukávky se dodávají v různých šířkách. Kontaktujte, prosím, Vašeho zástupce SKF.



Synchronní ozubené řemeny

XL

- ▶ Řemeny
- ▶ Řetězy
- ▶ Spojky
- ▶ Pouzdra a náboje
- ▶ Řetězová kola
- ▶ Řemenice
- ▶ Inteligentní nástroje

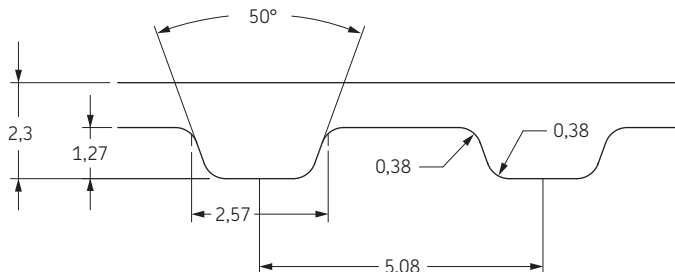

Typ řemenu	Počet zubů	Roztečná délka		Označení	Typ řemenu	Roztečná délka	Roztečná délka		Označení
		in	mm				in	mm	
44-XL	22	4,40	111,76	PHG 44-XL-...	206-XL	103	20,60	523,24	PHG 206-XL-...
60-XL	30	6,00	152,40	PHG 60-XL-...	208-XL	104	20,80	528,32	PHG 208-XL-...
70-XL	35	7,00	177,80	PHG 70-XL-...	210-XL	105	21,00	533,40	PHG 210-XL-...
76-XL	38	7,60	193,04	PHG 76-XL-...	212-XL	106	21,20	538,48	PHG 212-XL-...
80-XL	40	8,00	203,20	PHG 80-XL-...	214-XL	107	21,40	543,56	PHG 214-XL-...
82-XL	41	8,20	208,28	PHG 82-XL-...	220-XL	110	22,00	558,80	PHG 220-XL-...
84-XL	42	8,40	213,36	PHG 84-XL-...	228-XL	114	22,80	579,12	PHG 228-XL-...
88-XL	44	8,80	223,52	PHG 88-XL-...	230-XL	115	23,00	584,20	PHG 230-XL-...
90-XL	45	9,00	228,60	PHG 90-XL-...	234-XL	117	23,40	594,36	PHG 234-XL-...
92-XL	46	9,20	233,68	PHG 92-XL-...	236-XL	118	23,60	599,44	PHG 236-XL-...
94-XL	47	9,40	238,76	PHG 94-XL-...	240-XL	120	24,00	609,60	PHG 240-XL-...
96-XL	48	9,60	243,84	PHG 96-XL-...	248-XL	124	24,80	629,92	PHG 248-XL-...
98-XL	49	9,80	248,92	PHG 98-XL-...	250-XL	125	25,00	635,00	PHG 250-XL-...
100-XL	50	10,00	254,00	PHG 100-XL-...	256-XL	128	25,60	650,24	PHG 256-XL-...
102-XL	51	10,20	259,08	PHG 102-XL-...	260-XL	130	26,00	660,40	PHG 260-XL-...
104-XL	52	10,40	264,16	PHG 104-XL-...	270-XL	135	27,00	685,80	PHG 270-XL-...
106-XL	53	10,60	269,24	PHG 106-XL-...	276-XL	138	27,60	701,04	PHG 276-XL-...
108-XL	54	10,80	274,32	PHG 108-XL-...	280-XL	140	28,00	711,20	PHG 280-XL-...
110-XL	55	11,00	279,40	PHG 110-XL-...	282-XL	141	28,20	716,28	PHG 282-XL-...
112-XL	56	11,20	284,48	PHG 112-XL-...	286-XL	143	28,60	726,44	PHG 286-XL-...
114-XL	57	11,40	289,56	PHG 114-XL-...	290-XL	145	29,00	736,60	PHG 290-XL-...
116-XL	58	11,60	294,64	PHG 116-XL-...	300-XL	150	30,00	762,00	PHG 300-XL-...
118-XL	59	11,80	299,72	PHG 118-XL-...	304-XL	152	30,40	772,16	PHG 304-XL-...
120-XL	60	12,00	304,80	PHG 120-XL-...	310-XL	155	31,00	787,40	PHG 310-XL-...
122-XL	61	12,20	309,88	PHG 122-XL-...	316-XL	158	31,60	802,64	PHG 316-XL-...
124-XL	62	12,40	314,96	PHG 124-XL-...	320-XL	160	32,00	812,80	PHG 320-XL-...
126-XL	63	12,60	320,04	PHG 126-XL-...	326-XL	163	32,60	828,04	PHG 326-XL-...
128-XL	64	12,80	325,12	PHG 128-XL-...	330-XL	165	33,00	838,20	PHG 330-XL-...
130-XL	65	13,00	330,20	PHG 130-XL-...	340-XL	170	34,00	863,60	PHG 340-XL-...
132-XL	66	13,20	335,28	PHG 132-XL-...	344-XL	172	34,40	873,76	PHG 344-XL-...
134-XL	67	13,40	340,36	PHG 134-XL-...	348-XL	174	34,80	883,92	PHG 348-XL-...
136-XL	68	13,60	345,44	PHG 136-XL-...	352-XL	176	35,20	894,08	PHG 352-XL-...
140-XL	70	14,00	355,60	PHG 140-XL-...	360-XL	180	36,00	914,40	PHG 360-XL-...
142-XL	71	14,20	360,68	PHG 142-XL-...	364-XL	182	36,40	924,56	PHG 364-XL-...
144-XL	72	14,40	365,76	PHG 144-XL-...	372-XL	186	37,20	944,88	PHG 372-XL-...
146-XL	73	14,60	370,84	PHG 146-XL-...	376-XL	188	37,60	955,04	PHG 376-XL-...
150-XL	75	15,00	381,00	PHG 150-XL-...	380-XL	190	38,00	965,20	PHG 380-XL-...
152-XL	76	15,20	386,08	PHG 152-XL-...	384-XL	192	38,40	975,36	PHG 384-XL-...
154-XL	77	15,40	391,16	PHG 154-XL-...	390-XL	195	39,00	990,60	PHG 390-XL-...
156-XL	78	15,60	396,24	PHG 156-XL-...	400-XL	200	40,00	1016,00	PHG 400-XL-...
160-XL	80	16,00	406,40	PHG 160-XL-...	412-XL	206	41,20	1046,48	PHG 412-XL-...
162-XL	81	16,20	411,48	PHG 162-XL-...	414-XL	207	41,40	1051,56	PHG 414-XL-...
164-XL	82	16,40	416,56	PHG 164-XL-...	424-XL	212	42,40	1076,96	PHG 424-XL-...
166-XL	83	16,60	421,64	PHG 166-XL-...	432-XL	216	43,20	1097,28	PHG 432-XL-...
170-XL	85	17,00	431,80	PHG 170-XL-...	450-XL	225	45,00	1143,00	PHG 450-XL-...
172-XL	86	17,20	436,88	PHG 172-XL-...	460-XL	230	46,00	1168,40	PHG 460-XL-...
176-XL	88	17,60	447,04	PHG 176-XL-...	490-XL	245	49,00	1244,60	PHG 490-XL-...
180-XL	90	18,00	457,20	PHG 180-XL-...	564-XL	282	56,40	1432,56	PHG 564-XL-...
182-XL	91	18,20	462,28	PHG 182-XL-...	580-XL	290	58,00	1473,20	PHG 580-XL-...
184-XL	92	18,40	467,36	PHG 184-XL-...	612-XL	306	61,20	1554,48	PHG 612-XL-...
188-XL	94	18,80	477,52	PHG 188-XL-...	630-XL	315	63,00	1600,20	PHG 630-XL-...
190-XL	95	19,00	482,60	PHG 190-XL-...	670-XL	335	67,00	1701,80	PHG 670-XL-...
194-XL	97	19,40	492,76	PHG 194-XL-...	710-XL	355	71,00	1803,40	PHG 710-XL-...
196-XL	98	19,60	497,84	PHG 196-XL-...	720-XL	360	72,00	1828,80	PHG 720-XL-...
198-XL	99	19,80	502,92	PHG 198-XL-...	788-XL	394	78,80	2001,52	PHG 788-XL-...
200-XL	100	20,00	508,00	PHG 200-XL-...	860-XL	430	86,00	2184,40	PHG 860-XL-...
202-XL	101	20,20	513,08	PHG 202-XL-...	1032-XL	516	103,20	2621,28	PHG 1032-XL-...

K základnímu označení doplňte tři číslice, které vyjadřují šířku pásu v setinách palce, např. 025 pro šířku 1/4", popř. 037 pro šířku 3/8", aby označení bylo úplné.

Nabídka obsahuje rovněž nestandardní délky.

Řemenové rukávy se dodávají v různých šířkách. Kontaktujte, prosím, Vašeho zástupce SKF.



Synchronní ozubené řemeny

L

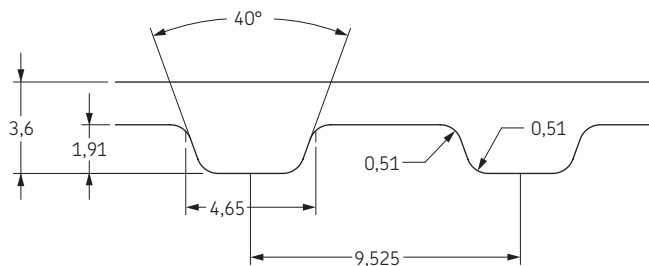

Typ řemenu	Počet zubů	Roztečná délka		Označení	Typ řemenu	Roztečná délka	Roztečná délka		Označení
		in	mm				in	mm	
67-L	18	6,75	171,45	PHG 67-L-...	371-L	99	37,13	942,98	PHG 371-L-...
98-L	26	9,75	247,65	PHG 98-L-...	375-L	100	37,50	952,50	PHG 375-L-...
109-L	29	10,88	276,23	PHG 109-L-...	382-L	102	38,25	971,55	PHG 382-L-...
113-L	30	11,25	285,75	PHG 113-L-...	387-L	103	38,63	981,08	PHG 387-L-...
124-L	33	12,38	314,33	PHG 124-L-...	390-L	104	39,00	990,60	PHG 390-L-...
130-L	35	13,13	333,38	PHG 130-L-...	394-L	105	39,38	1000,13	PHG 394-L-...
135-L	36	13,50	342,90	PHG 135-L-...	397-L	106	39,75	1009,65	PHG 397-L-...
143-L	38	14,25	361,95	PHG 143-L-...	405-L	108	40,50	1028,70	PHG 405-L-...
150-L	40	15,00	381,00	PHG 150-L-...	408-L	109	40,88	1038,23	PHG 408-L-...
154-L	41	15,38	390,53	PHG 154-L-...	412-L	110	41,25	1047,75	PHG 412-L-...
158-L	42	15,75	400,05	PHG 158-L-...	420-L	112	42,00	1066,80	PHG 420-L-...
160-L	43	16,13	409,58	PHG 160-L-...	427-L	114	42,75	1085,85	PHG 427-L-...
165-L	44	16,50	419,10	PHG 165-L-...	435-L	116	43,50	1104,90	PHG 435-L-...
169-L	45	16,88	428,63	PHG 169-L-...	439-L	117	43,88	1114,43	PHG 439-L-...
173-L	46	17,25	438,15	PHG 173-L-...	442-L	118	44,25	1123,95	PHG 442-L-...
177-L	47	17,63	447,68	PHG 177-L-...	450-L	120	45,00	1143,00	PHG 450-L-...
180-L	48	18,00	457,20	PHG 180-L-...	453-L	121	45,38	1152,53	PHG 453-L-...
185-L	49	18,38	466,73	PHG 185-L-...	465-L	124	46,50	1181,10	PHG 465-L-...
187-L	50	18,75	476,25	PHG 187-L-...	480-L	128	48,00	1219,20	PHG 480-L-...
191-L	51	19,13	485,78	PHG 191-L-...	495-L	132	49,50	1257,30	PHG 495-L-...
195-L	52	19,50	495,30	PHG 195-L-...	510-L	136	51,00	1295,40	PHG 510-L-...
203-L	54	20,25	514,35	PHG 203-L-...	525-L	140	52,50	1333,50	PHG 525-L-...
210-L	56	21,00	533,40	PHG 210-L-...	540-L	144	54,00	1371,60	PHG 540-L-...
214-L	57	21,38	542,93	PHG 214-L-...	548-L	146	54,75	1390,65	PHG 548-L-...
217-L	58	21,75	552,45	PHG 217-L-...	555-L	148	55,50	1409,70	PHG 555-L-...
225-L	60	22,50	571,50	PHG 225-L-...	570-L	152	57,00	1447,80	PHG 570-L-...
232-L	62	23,25	590,55	PHG 232-L-...	574-L	153	57,38	1457,33	PHG 574-L-...
240-L	64	24,00	609,60	PHG 240-L-...	581-L	155	58,13	1476,38	PHG 581-L-...
244-L	65	24,38	619,13	PHG 244-L-...	585-L	156	58,50	1485,90	PHG 585-L-...
255-L	68	25,50	647,70	PHG 255-L-...	600-L	160	60,00	1524,00	PHG 600-L-...
263-L	70	26,25	666,75	PHG 263-L-...	619-L	165	61,88	1571,63	PHG 619-L-...
265-L	71	26,63	676,28	PHG 265-L-...	630-L	168	63,00	1600,20	PHG 630-L-...
270-L	72	27,00	685,80	PHG 270-L-...	634-L	169	63,38	1609,73	PHG 634-L-...
275-L	73	27,38	695,33	PHG 275-L-...	660-L	176	66,00	1676,40	PHG 660-L-...
277-L	74	27,75	704,85	PHG 277-L-...	694-L	185	69,38	1762,13	PHG 694-L-...
280-L	75	28,13	714,38	PHG 280-L-...	697-L	186	69,75	1771,65	PHG 697-L-...
285-L	76	28,50	723,90	PHG 285-L-...	720-L	192	72,00	1828,80	PHG 720-L-...
300-L	80	30,00	762,00	PHG 300-L-...	728-L	194	72,75	1847,85	PHG 728-L-...
304-L	81	30,38	771,53	PHG 304-L-...	731-L	195	73,13	1857,38	PHG 731-L-...
315-L	84	31,50	800,10	PHG 315-L-...	765-L	204	76,50	1943,10	PHG 765-L-...
320-L	85	31,88	809,63	PHG 320-L-...	863-L	230	86,25	2190,75	PHG 863-L-...
322-L	86	32,25	819,15	PHG 322-L-...	881-L	235	88,13	2238,38	PHG 881-L-...
328-L	87	32,63	828,68	PHG 328-L-...	915-L	244	91,50	2324,10	PHG 915-L-...
330-L	88	33,00	838,20	PHG 330-L-...	934-L	249	93,38	2371,73	PHG 934-L-...
334-L	89	33,38	847,73	PHG 334-L-...	1028-L	274	102,75	2609,85	PHG 1028-L-...
337-L	90	33,75	857,25	PHG 337-L-...	1148-L	306	114,75	2914,65	PHG 1148-L-...
341-L	91	34,13	866,78	PHG 341-L-...	1192-L	318	119,25	3028,95	PHG 1192-L-...
345-L	92	34,50	876,30	PHG 345-L-...	1406-L	375	140,63	3571,88	PHG 1406-L-...
352-L	94	35,25	895,35	PHG 352-L-...	1418-L	378	141,75	3600,45	PHG 1418-L-...
360-L	96	36,00	914,40	PHG 360-L-...	1675-L	447	167,63	4257,68	PHG 1675-L-...
367-L	98	36,75	933,45	PHG 367-L-...	1998-L	530	198,75	5048,25	PHG 1998-L-...

K základnímu označení doplňte tři číslice, které vyjadřují šířku pásu v setinách palce, např. 050 pro šířku 1/2", popř. 075 pro šířku 3/4", aby označení bylo úplné.

Nabídka obsahuje rovněž nestandardní délky.

Řemenové rukávy se dodávají v různých šířkách. Kontaktujte, prosím, Vašeho zástupce SKF.



Synchronní ozubené řemeny

H

- ▶ Řemeny
- ▶ Řetězy
- ▶ Spojky
- ▶ Pouzdra a náboje
- ▶ Řetězová kola
- ▶ Řemenice
- ▶ Inteligentní nástroje

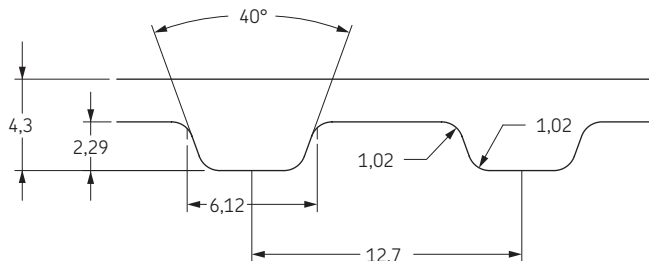

Typ řemenu	Počet zubů	Roztečná délka		Označení	Typ řemenu	Počet zubů	Roztečná délka		Označení
		in	mm				in	mm	
185-H	37	18,50	469,90	PHG 185-H-...	605-H	121	60,50	1536,70	PHG 605-H-...
200-H	40	20,00	508,00	PHG 200-H-...	630-H	126	63,00	1600,20	PHG 630-H-...
210-H	42	21,00	533,40	PHG 210-H-...	640-H	128	64,00	1625,60	PHG 640-H-...
220-H	44	22,00	558,80	PHG 220-H-...	650-H	130	65,00	1651,00	PHG 650-H-...
225-H	45	22,50	571,50	PHG 225-H-...	660-H	132	66,00	1676,40	PHG 660-H-...
230-H	46	23,00	584,20	PHG 230-H-...	670-H	134	67,00	1701,80	PHG 670-H-...
240-H	48	24,00	609,60	PHG 240-H-...	680-H	136	68,00	1727,20	PHG 680-H-...
250-H	50	25,00	635,00	PHG 250-H-...	700-H	140	70,00	1778,00	PHG 700-H-...
255-H	51	25,50	647,70	PHG 255-H-...	710-H	142	71,00	1803,40	PHG 710-H-...
260-H	52	26,00	660,40	PHG 260-H-...	720-H	144	72,00	1828,80	PHG 720-H-...
270-H	54	27,00	685,80	PHG 270-H-...	725-H	145	72,50	1841,50	PHG 725-H-...
280-H	56	28,00	711,20	PHG 280-H-...	730-H	146	73,00	1854,20	PHG 730-H-...
285-H	57	28,50	723,90	PHG 285-H-...	740-H	148	74,00	1879,60	PHG 740-H-...
290-H	58	29,00	736,60	PHG 290-H-...	750-H	150	75,00	1905,00	PHG 750-H-...
300-H	60	30,00	762,00	PHG 300-H-...	770-H	154	77,00	1955,80	PHG 770-H-...
310-H	62	31,00	787,40	PHG 310-H-...	785-H	157	78,50	1993,90	PHG 785-H-...
315-H	63	31,50	800,10	PHG 315-H-...	800-H	160	80,00	2032,00	PHG 800-H-...
320-H	64	32,00	812,80	PHG 320-H-...	810-H	162	81,00	2057,40	PHG 810-H-...
325-H	65	32,50	825,50	PHG 325-H-...	820-H	164	82,00	2082,80	PHG 820-H-...
330-H	66	33,00	838,20	PHG 330-H-...	840-H	168	84,00	2133,60	PHG 840-H-...
335-H	67	33,50	850,90	PHG 335-H-...	850-H	170	85,00	2159,00	PHG 850-H-...
340-H	68	34,00	863,60	PHG 340-H-...	860-H	172	86,00	2184,40	PHG 860-H-...
345-H	69	34,50	876,30	PHG 345-H-...	880-H	176	88,00	2235,20	PHG 880-H-...
350-H	70	35,00	889,00	PHG 350-H-...	900-H	180	90,00	2286,00	PHG 900-H-...
355-H	71	35,50	901,70	PHG 355-H-...	930-H	186	93,00	2362,20	PHG 930-H-...
360-H	72	36,00	914,40	PHG 360-H-...	950-H	190	95,00	2413,00	PHG 950-H-...
365-H	73	36,50	927,10	PHG 365-H-...	960-H	192	96,00	2438,40	PHG 960-H-...
370-H	74	37,00	939,80	PHG 370-H-...	980-H	196	98,00	2489,20	PHG 980-H-...
375-H	75	37,50	952,50	PHG 375-H-...	985-H	197	98,50	2501,90	PHG 985-H-...
380-H	76	38,00	965,20	PHG 380-H-...	1000-H	200	100,00	2540,00	PHG 1000-H-...
390-H	78	39,00	990,60	PHG 390-H-...	1020-H	204	102,00	2590,80	PHG 1020-H-...
395-H	79	39,50	1003,30	PHG 395-H-...	1050-H	210	105,00	2667,00	PHG 1050-H-...
400-H	80	40,00	1016,00	PHG 400-H-...	1085-H	217	108,50	2755,90	PHG 1085-H-...
405-H	81	40,50	1028,70	PHG 405-H-...	1100-H	220	110,00	2794,00	PHG 1100-H-...
410-H	82	41,00	1041,40	PHG 410-H-...	1120-H	224	112,00	2844,80	PHG 1120-H-...
420-H	84	42,00	1066,80	PHG 420-H-...	1130-H	226	113,00	2870,20	PHG 1130-H-...
430-H	86	43,00	1092,20	PHG 430-H-...	1140-H	228	114,00	2895,60	PHG 1140-H-...
445-H	89	44,50	1130,30	PHG 445-H-...	1150-H	230	115,00	2921,00	PHG 1150-H-...
450-H	90	45,00	1143,00	PHG 450-H-...	1175-H	235	117,50	2984,50	PHG 1175-H-...
460-H	92	46,00	1168,40	PHG 460-H-...	1200-H	240	120,00	3048,00	PHG 1200-H-...
465-H	93	46,50	1181,10	PHG 465-H-...	1250-H	250	125,00	3175,00	PHG 1250-H-...
470-H	94	47,00	1193,80	PHG 470-H-...	1260-H	252	126,00	3200,40	PHG 1260-H-...
480-H	96	48,00	1219,20	PHG 480-H-...	1270-H	254	127,00	3225,80	PHG 1270-H-...
485-H	97	48,50	1231,90	PHG 485-H-...	1325-H	265	132,50	3365,50	PHG 1325-H-...
490-H	98	49,00	1244,60	PHG 490-H-...	1350-H	270	135,00	3429,00	PHG 1350-H-...
500-H	100	50,00	1270,00	PHG 500-H-...	1400-H	280	140,00	3556,00	PHG 1400-H-...
510-H	102	51,00	1295,40	PHG 510-H-...	1440-H	288	144,00	3657,60	PHG 1440-H-...
515-H	103	51,50	1308,10	PHG 515-H-...	1450-H	290	145,00	3683,00	PHG 1450-H-...
520-H	104	52,00	1320,80	PHG 520-H-...	1510-H	302	151,00	3835,40	PHG 1510-H-...
525-H	105	52,50	1333,50	PHG 525-H-...	1535-H	307	153,50	3898,90	PHG 1535-H-...
530-H	106	53,00	1346,20	PHG 530-H-...	1550-H	310	155,00	3937,00	PHG 1550-H-...
540-H	108	54,00	1371,60	PHG 540-H-...	1560-H	312	156,00	3962,40	PHG 1560-H-...
550-H	110	55,00	1397,00	PHG 550-H-...	1600-H	320	160,00	4064,00	PHG 1600-H-...
560-H	112	56,00	1422,40	PHG 560-H-...	1630-H	326	163,00	4140,20	PHG 1630-H-...
565-H	113	56,50	1435,10	PHG 565-H-...	1660-H	332	166,00	4216,40	PHG 1660-H-...
570-H	114	57,00	1447,80	PHG 570-H-...	1700-H	340	170,00	4318,00	PHG 1700-H-...
580-H	116	58,00	1473,20	PHG 580-H-...	1855-H	371	185,50	4711,70	PHG 1855-H-...
585-H	117	58,50	1485,90	PHG 585-H-...	2200-H	440	220,00	5588,00	PHG 2200-H-...
590-H	118	59,00	1498,60	PHG 590-H-...	2360-H	472	236,00	5994,40	PHG 2360-H-...
600-H	120	60,00	1524,00	PHG 600-H-...	2500-H	500	250,00	6350,00	PHG 2500-H-...

K základnímu označení doplňte tři číslice, které vyjadřují šířku pásu v setinách palce, např. 050 pro šířku 1/2", popř. 075 pro šířku 3/4", aby označení bylo úplné.

Nabídka obsahuje rovněž nestandardní délky.

Řemenové rukávy se dodávají v různých šířkách. Kontaktujte, prosím, Vašeho zástupce SKF.

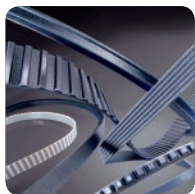

Synchronní ozubené řemeny

XH, XXH



Typ řemenu	Počet zubů	Roztečná délka		Označení
		in	mm	
463-XH	53	46,38	1177,93	PHG 463-XH-...
508-XH	58	50,75	1289,05	PHG 508-XH-...
560-XH	64	56,00	1422,40	PHG 560-XH-...
570-XH	65	56,88	1444,63	PHG 570-XH-...
580-XH	66	57,75	1466,85	PHG 580-XH-...
604-XH	69	60,38	1533,53	PHG 604-XH-...
630-XH	72	63,00	1600,20	PHG 630-XH-...
700-XH	80	70,00	1778,00	PHG 700-XH-...
735-XH	84	73,50	1866,90	PHG 735-XH-...
752-XH	86	75,25	1911,35	PHG 752-XH-...
770-XH	88	77,00	1955,80	PHG 770-XH-...
800-XH	91	79,63	2022,48	PHG 800-XH-...
805-XH	92	80,50	2044,70	PHG 805-XH-...
840-XH	96	84,00	2133,60	PHG 840-XH-...
901-XH	103	90,13	2289,18	PHG 901-XH-...
919-XH	105	91,88	2333,63	PHG 919-XH-...
927-XH	106	92,75	2355,85	PHG 927-XH-...
980-XH	112	98,00	2489,20	PHG 980-XH-...
1000-XH	114	99,75	2533,65	PHG 1000-XH-...
1120-XH	128	112,00	2844,80	PHG 1120-XH-...
1260-XH	144	126,00	3200,40	PHG 1260-XH-...
1400-XH	160	140,00	3556,00	PHG 1400-XH-...
1540-XH	176	154,00	3911,60	PHG 1540-XH-...
1575-XH	180	157,50	4000,50	PHG 1575-XH-...
1750-XH	200	175,00	4445,00	PHG 1750-XH-...
1873-XH	214	187,25	4756,15	PHG 1873-XH-...
2275-XH	260	227,50	5778,50	PHG 2275-XH-...

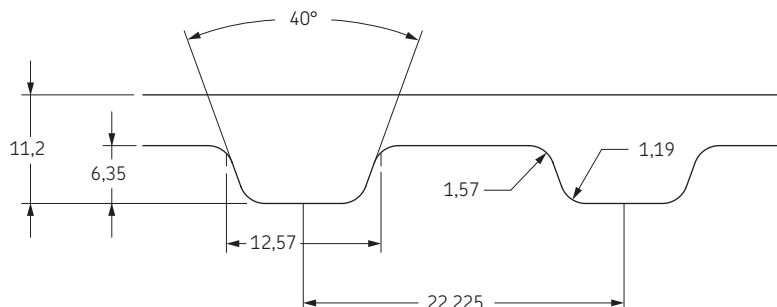

Typ řemenu	Počet zubů	Roztečná délka		Označení
		in	mm	
625-XXH	50	62,50	1587,50	PHG 625-XXH-...
650-XXH	52	65,00	1651,00	PHG 650-XXH-...
700-XXH	56	70,00	1778,00	PHG 700-XXH-...
800-XXH	64	80,00	2032,00	PHG 800-XXH-...
900-XXH	72	90,00	2286,00	PHG 900-XXH-...
950-XXH	76	95,00	2413,00	PHG 950-XXH-...
1000-XXH	80	100,00	2540,00	PHG 1000-XXH-...
1050-XXH	84	105,00	2667,00	PHG 1050-XXH-...
1200-XXH	96	120,00	3048,00	PHG 1200-XXH-...
1250-XXH	100	125,00	3175,00	PHG 1250-XXH-...
1400-XXH	112	140,00	3556,00	PHG 1400-XXH-...
1563-XXH	125	156,25	3968,75	PHG 1563-XXH-...
1600-XXH	128	160,00	4064,00	PHG 1600-XXH-...
1700-XXH	136	170,00	4318,00	PHG 1700-XXH-...
1800-XXH	144	180,00	4572,00	PHG 1800-XXH-...
1925-XXH	154	192,50	4889,50	PHG 1925-XXH-...

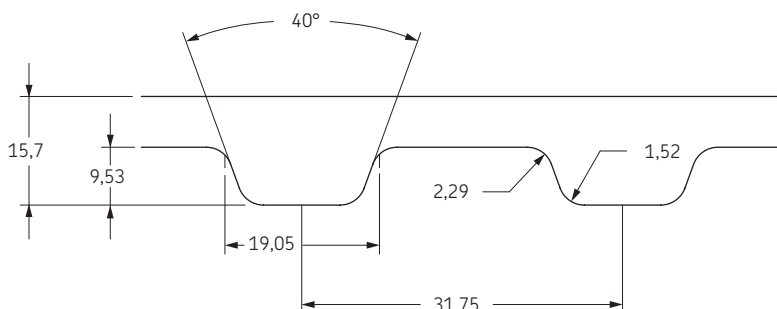

K základnímu označení doplňte tři číslice, které vyjadřují šířku pásu v setinách palce, např. 100 pro šířku 1", popř. 200 pro šířku 2", aby označení bylo úplné.

Nabídka obsahuje rovněž nestandardní délky.

Řemenové rukávy se dodávají v různých šířkách. Kontaktujte, prosím, Vašeho zástupce SKF.



Oboustranné synchronní ozubené řemeny

D-XL

- ▶ Řemeny
- ▶ Řetězy
- ▶ Spojky
- ▶ Pouzdra a náboje
- ▶ Řetězová kola
- ▶ Řemenice
- ▶ Inteligentní nástroje

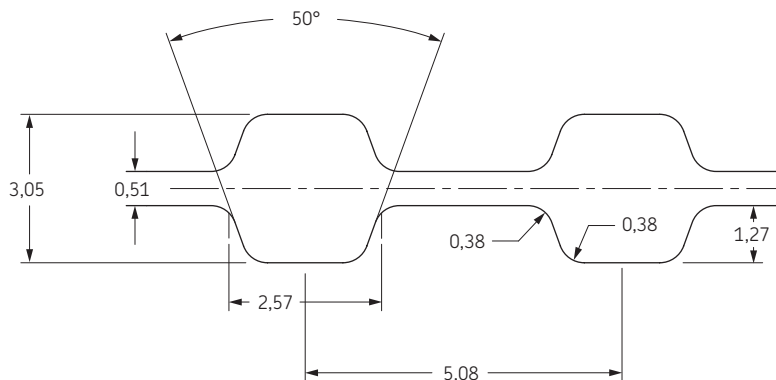

Typ řemenu	Počet zubů na jedné straně	Roztečná délka		Označení	Typ řemenu	Počet zubů na jedné straně	Roztečná délka		Označení
		in	mm				in	mm	
D-198-XL	99	19,80	502,92	PHG D-198-XL-...	D-310-XL	155	31,00	787,40	PHG D-310-XL-...
D-200-XL	100	20,00	508,00	PHG D-200-XL-...	D-316-XL	158	31,60	802,64	PHG D-316-XL-...
D-202-XL	101	20,20	513,08	PHG D-202-XL-...	D-320-XL	160	32,00	812,80	PHG D-320-XL-...
D-206-XL	103	20,60	523,24	PHG D-206-XL-...	D-326-XL	163	32,60	828,04	PHG D-326-XL-...
D-208-XL	104	20,80	528,32	PHG D-208-XL-...	D-330-XL	165	33,00	838,20	PHG D-330-XL-...
D-210-XL	105	21,00	533,40	PHG D-210-XL-...	D-340-XL	170	34,00	863,60	PHG D-340-XL-...
D-212-XL	106	21,20	538,48	PHG D-212-XL-...	D-344-XL	172	34,40	873,76	PHG D-344-XL-...
D-214-XL	107	21,40	543,56	PHG D-214-XL-...	D-348-XL	174	34,80	883,92	PHG D-348-XL-...
D-220-XL	110	22,00	558,80	PHG D-220-XL-...	D-352-XL	176	35,20	894,08	PHG D-352-XL-...
D-228-XL	114	22,80	579,12	PHG D-228-XL-...	D-360-XL	180	36,00	914,40	PHG D-360-XL-...
D-230-XL	115	23,00	584,20	PHG D-230-XL-...	D-364-XL	182	36,40	924,56	PHG D-364-XL-...
D-234-XL	117	23,40	594,36	PHG D-234-XL-...	D-372-XL	186	37,20	944,88	PHG D-372-XL-...
D-236-XL	118	23,60	599,44	PHG D-236-XL-...	D-376-XL	188	37,60	955,04	PHG D-376-XL-...
D-240-XL	120	24,00	609,60	PHG D-240-XL-...	D-380-XL	190	38,00	965,20	PHG D-380-XL-...
D-248-XL	124	24,80	629,92	PHG D-248-XL-...	D-384-XL	192	38,40	975,36	PHG D-384-XL-...
D-250-XL	125	25,00	635,00	PHG D-250-XL-...	D-390-XL	195	39,00	990,60	PHG D-390-XL-...
D-256-XL	128	25,60	650,24	PHG D-256-XL-...	D-400-XL	200	40,00	1016,00	PHG D-400-XL-...
D-260-XL	130	26,00	660,40	PHG D-260-XL-...	D-412-XL	206	41,20	1046,48	PHG D-412-XL-...
D-270-XL	135	27,00	685,80	PHG D-270-XL-...	D-414-XL	207	41,40	1051,56	PHG D-414-XL-...
D-276-XL	138	27,60	701,04	PHG D-276-XL-...	D-424-XL	212	42,40	1076,96	PHG D-424-XL-...
D-280-XL	140	28,00	711,20	PHG D-280-XL-...	D-432-XL	216	43,20	1097,28	PHG D-432-XL-...
D-282-XL	141	28,20	716,28	PHG D-282-XL-...	D-450-XL	225	45,00	1143,00	PHG D-450-XL-...
D-286-XL	143	28,60	726,44	PHG D-286-XL-...	D-460-XL	230	46,00	1168,40	PHG D-460-XL-...
D-290-XL	145	29,00	736,60	PHG D-290-XL-...	D-490-XL	245	49,00	1244,60	PHG D-490-XL-...
D-300-XL	150	30,00	762,00	PHG D-300-XL-...	D-564-XL	282	56,40	1432,56	PHG D-564-XL-...
D-304-XL	152	30,40	772,16	PHG D-304-XL-...	D-580-XL	290	58,00	1473,20	PHG D-580-XL-...

K základnímu označení doplňte tři číslice, které vyjadřují šířku pásu v setinách palce, např. 025 pro šířku 1/4", popř. 037 pro šířku 3/8", aby označení bylo úplné.

Nabídka obsahuje rovněž nestandardní délky.

Řemenové rukávy se dodávají v různých šířkách. Kontaktujte, prosím, Vašeho zástupce SKF.

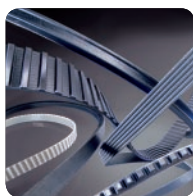

Oboustranné synchronní ozubené řemeny

D-L

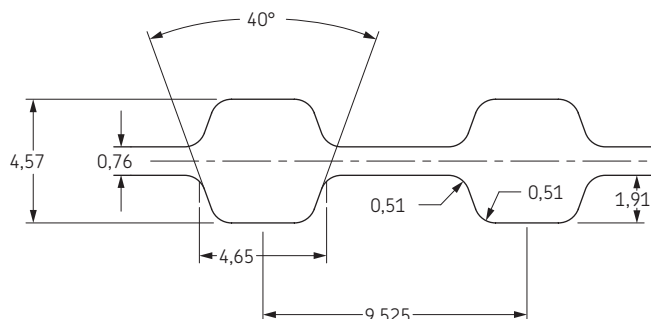
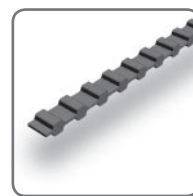

Typ řemenu	Počet zubů na jedné straně	Roztečná délka		Označení	Typ řemenu	Počet zubů na jedné straně	Roztečná délka		Označení
		in	mm				in	mm	
D-203-L	54	20,25	514,35	PHG D-203-L-...	D-371-L	99	37,13	942,98	PHG D-371-L-...
D-210-L	56	21,00	533,40	PHG D-210-L-...	D-375-L	100	37,50	952,50	PHG D-375-L-...
D-214-L	57	21,38	542,93	PHG D-214-L-...	D-382-L	102	38,25	971,55	PHG D-382-L-...
D-217-L	58	21,75	552,45	PHG D-217-L-...	D-387-L	103	38,63	981,08	PHG D-387-L-...
D-225-L	60	22,50	571,50	PHG D-225-L-...	D-390-L	104	39,00	990,60	PHG D-390-L-...
D-232-L	62	23,25	590,55	PHG D-232-L-...	D-394-L	105	39,38	1000,13	PHG D-394-L-...
D-240-L	64	24,00	609,60	PHG D-240-L-...	D-397-L	106	39,75	1009,65	PHG D-397-L-...
D-244-L	65	24,38	619,13	PHG D-244-L-...	D-405-L	108	40,50	1028,70	PHG D-405-L-...
D-255-L	68	25,50	647,70	PHG D-255-L-...	D-408-L	109	40,88	1038,23	PHG D-408-L-...
D-263-L	70	26,25	666,75	PHG D-263-L-...	D-412-L	110	41,25	1047,75	PHG D-412-L-...
D-265-L	71	26,63	676,28	PHG D-265-L-...	D-420-L	112	42,00	1066,80	PHG D-420-L-...
D-270-L	72	27,00	685,80	PHG D-270-L-...	D-427-L	114	42,75	1085,85	PHG D-427-L-...
D-275-L	73	27,38	695,33	PHG D-275-L-...	D-435-L	116	43,50	1104,90	PHG D-435-L-...
D-277-L	74	27,75	704,85	PHG D-277-L-...	D-439-L	117	43,88	1114,43	PHG D-439-L-...
D-280-L	75	28,13	714,38	PHG D-280-L-...	D-442-L	118	44,25	1123,95	PHG D-442-L-...
D-285-L	76	28,50	723,90	PHG D-285-L-...	D-450-L	120	45,00	1143,00	PHG D-450-L-...
D-300-L	80	30,00	762,00	PHG D-300-L-...	D-453-L	121	45,38	1152,53	PHG D-453-L-...
D-304-L	81	30,38	771,53	PHG D-304-L-...	D-465-L	124	46,50	1181,10	PHG D-465-L-...
D-315-L	84	31,50	800,10	PHG D-315-L-...	D-480-L	128	48,00	1219,20	PHG D-480-L-...
D-320-L	85	31,88	809,63	PHG D-320-L-...	D-495-L	132	49,50	1257,30	PHG D-495-L-...
D-322-L	86	32,25	819,15	PHG D-322-L-...	D-510-L	136	51,00	1295,40	PHG D-510-L-...
D-328-L	87	32,63	828,68	PHG D-328-L-...	D-525-L	140	52,50	1333,50	PHG D-525-L-...
D-330-L	88	33,00	838,20	PHG D-330-L-...	D-540-L	144	54,00	1371,60	PHG D-540-L-...
D-334-L	89	33,38	847,73	PHG D-334-L-...	D-548-L	146	54,75	1390,65	PHG D-548-L-...
D-337-L	90	33,75	857,25	PHG D-337-L-...	D-555-L	148	55,50	1409,70	PHG D-555-L-...
D-341-L	91	34,13	866,78	PHG D-341-L-...	D-570-L	152	57,00	1447,80	PHG D-570-L-...
D-345-L	92	34,50	876,30	PHG D-345-L-...	D-574-L	153	57,38	1457,33	PHG D-574-L-...
D-352-L	94	35,25	895,35	PHG D-352-L-...	D-581-L	155	58,13	1476,38	PHG D-581-L-...
D-360-L	96	36,00	914,40	PHG D-360-L-...	D-585-L	156	58,50	1485,90	PHG D-585-L-...
D-367-L	98	36,75	933,45	PHG D-367-L-...	-	-	-	-	-

K základnímu označení doplňte tři číselce, které vyjadřují šířku pásu v setinách palce, např. 050 pro šířku 1/2", popř. 075 pro šířku 3/4", aby označení bylo úplné.

Nabídka obsahuje rovněž nestandardní délky.

Řemenové rukávy se dodávají v různých šířkách. Kontaktujte, prosím, Vašeho zástupce SKF.



Oboustranné synchronní ozubené řemeny

D-H

- ▶ Řemeny
- ▶ Řetězy
- ▶ Spojky
- ▶ Pouzdra a náboje
- ▶ Řetězová kola
- ▶ Řemenice
- ▶ Inteligentní nástroje

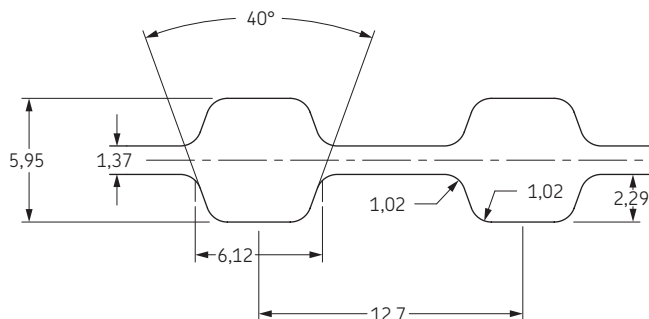

Typ řemenu	Počet zubů na jedné straně	Rozečná délka		Označení	Typ řemenu	Počet zubů na jedné straně	Rozečná délka		Označení
		in	mm				in	mm	
D-200-H	40	20,00	508,00	PHG D-200-H-...	D-605-H	121	60,50	1536,70	PHG D-605-H-...
D-210-H	42	21,00	533,40	PHG D-210-H-...	D-630-H	126	63,00	1600,20	PHG D-630-H-...
D-220-H	44	22,00	558,80	PHG D-220-H-...	D-640-H	128	64,00	1625,60	PHG D-640-H-...
D-225-H	45	22,50	571,50	PHG D-225-H-...	D-650-H	130	65,00	1651,00	PHG D-650-H-...
D-230-H	46	23,00	584,20	PHG D-230-H-...	D-660-H	132	66,00	1676,40	PHG D-660-H-...
D-240-H	48	24,00	609,60	PHG D-240-H-...	D-670-H	134	67,00	1701,80	PHG D-670-H-...
D-245-H	49	24,50	622,30	PHG D-245-H-...	D-680-H	136	68,00	1727,20	PHG D-680-H-...
D-250-H	50	25,00	635,00	PHG D-250-H-...	D-700-H	140	70,00	1778,00	PHG D-700-H-...
D-255-H	51	25,50	647,70	PHG D-255-H-...	D-710-H	142	71,00	1803,40	PHG D-710-H-...
D-260-H	52	26,00	660,40	PHG D-260-H-...	D-720-H	144	72,00	1828,80	PHG D-720-H-...
D-270-H	54	27,00	685,80	PHG D-270-H-...	D-725-H	145	72,50	1841,50	PHG D-725-H-...
D-280-H	56	28,00	711,20	PHG D-280-H-...	D-730-H	146	73,00	1854,20	PHG D-730-H-...
D-285-H	57	28,50	723,90	PHG D-285-H-...	D-740-H	148	74,00	1879,60	PHG D-740-H-...
D-290-H	58	29,00	736,60	PHG D-290-H-...	D-750-H	150	75,00	1905,00	PHG D-750-H-...
D-300-H	60	30,00	762,00	PHG D-300-H-...	D-770-H	154	77,00	1955,80	PHG D-770-H-...
D-310-H	62	31,00	787,40	PHG D-310-H-...	D-785-H	157	78,50	1993,90	PHG D-785-H-...
D-315-H	63	31,50	800,10	PHG D-315-H-...	D-800-H	160	80,00	2032,00	PHG D-800-H-...
D-320-H	64	32,00	812,80	PHG D-320-H-...	D-810-H	162	81,00	2057,40	PHG D-810-H-...
D-325-H	65	32,50	825,50	PHG D-325-H-...	D-820-H	164	82,00	2082,80	PHG D-820-H-...
D-330-H	66	33,00	838,20	PHG D-330-H-...	D-840-H	168	84,00	2133,60	PHG D-840-H-...
D-335-H	67	33,50	850,90	PHG D-335-H-...	D-850-H	170	85,00	2159,00	PHG D-850-H-...
D-340-H	68	34,00	863,60	PHG D-340-H-...	D-860-H	172	86,00	2184,40	PHG D-860-H-...
D-345-H	69	34,50	876,30	PHG D-345-H-...	D-880-H	176	88,00	2235,20	PHG D-880-H-...
D-350-H	70	35,00	889,00	PHG D-350-H-...	D-900-H	180	90,00	2286,00	PHG D-900-H-...
D-355-H	71	35,50	901,70	PHG D-355-H-...	D-930-H	186	93,00	2362,20	PHG D-930-H-...
D-360-H	72	36,00	914,40	PHG D-360-H-...	D-950-H	190	95,00	2413,00	PHG D-950-H-...
D-365-H	73	36,50	927,10	PHG D-365-H-...	D-960-H	192	96,00	2438,40	PHG D-960-H-...
D-370-H	74	37,00	939,80	PHG D-370-H-...	D-980-H	196	98,00	2489,20	PHG D-980-H-...
D-375-H	75	37,50	952,50	PHG D-375-H-...	D-985-H	197	98,50	2501,90	PHG D-985-H-...
D-380-H	76	38,00	965,20	PHG D-380-H-...	D-1000-H	200	100,00	2540,00	PHG D-1000-H-...
D-390-H	78	39,00	990,60	PHG D-390-H-...	D-1020-H	204	102,00	2590,80	PHG D-1020-H-...
D-395-H	79	39,50	1003,30	PHG D-395-H-...	D-1050-H	210	105,00	2667,00	PHG D-1050-H-...
D-400-H	80	40,00	1016,00	PHG D-400-H-...	D-1085-H	217	108,50	2755,90	PHG D-1085-H-...
D-405-H	81	40,50	1028,70	PHG D-405-H-...	D-1100-H	220	110,00	2794,00	PHG D-1100-H-...
D-410-H	82	41,00	1041,40	PHG D-410-H-...	D-1120-H	224	112,00	2844,80	PHG D-1120-H-...
D-420-H	84	42,00	1066,80	PHG D-420-H-...	D-1130-H	226	113,00	2870,20	PHG D-1130-H-...
D-430-H	86	43,00	1092,20	PHG D-430-H-...	D-1140-H	228	114,00	2895,60	PHG D-1140-H-...
D-445-H	89	44,50	1130,30	PHG D-445-H-...	D-1150-H	230	115,00	2921,00	PHG D-1150-H-...
D-450-H	90	45,00	1143,00	PHG D-450-H-...	D-1175-H	235	117,50	2984,50	PHG D-1175-H-...
D-460-H	92	46,00	1168,40	PHG D-460-H-...	D-1200-H	240	120,00	3048,00	PHG D-1200-H-...
D-465-H	93	46,50	1181,10	PHG D-465-H-...	D-1250-H	250	125,00	3175,00	PHG D-1250-H-...
D-470-H	94	47,00	1193,80	PHG D-470-H-...	D-1260-H	252	126,00	3200,40	PHG D-1260-H-...
D-480-H	96	48,00	1219,20	PHG D-480-H-...	D-1270-H	254	127,00	3225,80	PHG D-1270-H-...
D-485-H	97	48,50	1231,90	PHG D-485-H-...	D-1325-H	265	132,50	3365,50	PHG D-1325-H-...
D-490-H	98	49,00	1244,60	PHG D-490-H-...	D-1350-H	270	135,00	3429,00	PHG D-1350-H-...
D-500-H	100	50,00	1270,00	PHG D-500-H-...	D-1400-H	280	140,00	3556,00	PHG D-1400-H-...
D-510-H	102	51,00	1295,40	PHG D-510-H-...	D-1440-H	288	144,00	3657,60	PHG D-1440-H-...
D-515-H	103	51,50	1308,10	PHG D-515-H-...	D-1450-H	290	145,00	3683,00	PHG D-1450-H-...
D-520-H	104	52,00	1320,80	PHG D-520-H-...	D-1510-H	302	151,00	3835,40	PHG D-1510-H-...
D-525-H	105	52,50	1333,50	PHG D-525-H-...	D-1535-H	307	153,50	3898,90	PHG D-1535-H-...
D-530-H	106	53,00	1346,20	PHG D-530-H-...	D-1550-H	310	155,00	3937,00	PHG D-1550-H-...
D-540-H	108	54,00	1371,60	PHG D-540-H-...	D-1560-H	312	156,00	3962,40	PHG D-1560-H-...
D-550-H	110	55,00	1397,00	PHG D-550-H-...	D-1600-H	320	160,00	4064,00	PHG D-1600-H-...
D-560-H	112	56,00	1422,40	PHG D-560-H-...	D-1630-H	326	163,00	4140,20	PHG D-1630-H-...
D-565-H	113	56,50	1435,10	PHG D-565-H-...	D-1660-H	332	166,00	4216,40	PHG D-1660-H-...
D-570-H	114	57,00	1447,80	PHG D-570-H-...	D-1700-H	340	170,00	4318,00	PHG D-1700-H-...
D-580-H	116	58,00	1473,20	PHG D-580-H-...	D-1855-H	371	185,50	4711,70	PHG D-1855-H-...
D-585-H	117	58,50	1485,90	PHG D-585-H-...	D-2200-H	440	220,00	5588,00	PHG D-2200-H-...
D-590-H	118	59,00	1498,60	PHG D-590-H-...	D-2360-H	472	236,00	5994,40	PHG D-2360-H-...
D-600-H	120	60,00	1524,00	PHG D-600-H-...	D-2500-H	500	250,00	6350,00	PHG D-2500-H-...

K základnímu označení doplňte tři číslice, které vyjadřují šířku pásu v setinách palce, např. 050 pro šířku 1/2", popř. 100 pro šířku 1", aby označení bylo úplné.

Nabídka obsahuje rovněž nestandardní délky.

Řemenové rukávy se dodávají v různých šířkách. Kontaktujte, prosím, Vašeho zástupce SKF.



Synchronní řemeny HiTD

3M

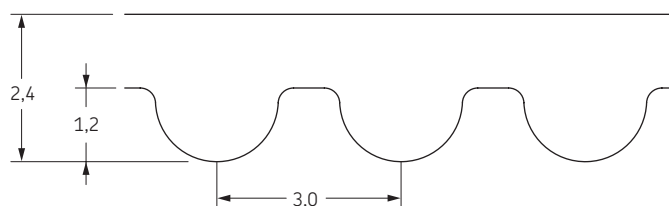
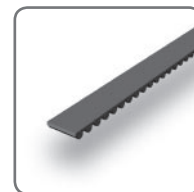

Typ řemenu	Počet zubů	Roztečná délka mm	Označení	Typ řemenu	Počet zubů	Roztečná délka mm	Označení	Typ řemenu	Počet zubů	Roztečná délka mm	Označení
60-3M	20	60	PHG 60-3M-...	288-3M	96	288	PHG 288-3M-...	564-3M	188	564	PHG 564-3M-...
81-3M	27	81	PHG 81-3M-...	291-3M	97	291	PHG 291-3M-...	576-3M	192	576	PHG 576-3M-...
87-3M	29	87	PHG 87-3M-...	300-3M	100	300	PHG 300-3M-...	579-3M	193	579	PHG 579-3M-...
111-3M	37	111	PHG 111-3M-...	306-3M	102	306	PHG 306-3M-...	582-3M	194	582	PHG 582-3M-...
117-3M	39	117	PHG 117-3M-...	309-3M	103	309	PHG 309-3M-...	597-3M	199	597	PHG 597-3M-...
120-3M	40	120	PHG 120-3M-...	312-3M	104	312	PHG 312-3M-...	606-3M	202	606	PHG 606-3M-...
129-3M	43	129	PHG 129-3M-...	318-3M	106	318	PHG 318-3M-...	609-3M	203	609	PHG 609-3M-...
141-3M	47	141	PHG 141-3M-...	324-3M	108	324	PHG 324-3M-...	612-3M	204	612	PHG 612-3M-...
144-3M	48	144	PHG 144-3M-...	327-3M	109	327	PHG 327-3M-...	633-3M	211	633	PHG 633-3M-...
150-3M	50	150	PHG 150-3M-...	333-3M	111	333	PHG 333-3M-...	639-3M	213	639	PHG 639-3M-...
153-3M	51	153	PHG 153-3M-...	336-3M	112	336	PHG 336-3M-...	648-3M	216	648	PHG 648-3M-...
156-3M	52	156	PHG 156-3M-...	339-3M	113	339	PHG 339-3M-...	654-3M	218	654	PHG 654-3M-...
159-3M	53	159	PHG 159-3M-...	342-3M	114	342	PHG 342-3M-...	669-3M	223	669	PHG 669-3M-...
162-3M	54	162	PHG 162-3M-...	345-3M	115	345	PHG 345-3M-...	675-3M	225	675	PHG 675-3M-...
165-3M	55	165	PHG 165-3M-...	348-3M	116	348	PHG 348-3M-...	684-3M	228	684	PHG 684-3M-...
168-3M	56	168	PHG 168-3M-...	357-3M	119	357	PHG 357-3M-...	669-3M	233	699	PHG 669-3M-...
171-3M	57	171	PHG 171-3M-...	360-3M	120	360	PHG 360-3M-...	708-3M	236	708	PHG 708-3M-...
174-3M	58	174	PHG 174-3M-...	363-3M	121	363	PHG 363-3M-...	711-3M	237	711	PHG 711-3M-...
177-3M	59	177	PHG 177-3M-...	366-3M	122	366	PHG 366-3M-...	720-3M	240	720	PHG 720-3M-...
180-3M	60	180	PHG 180-3M-...	375-3M	125	375	PHG 375-3M-...	750-3M	250	750	PHG 750-3M-...
186-3M	62	186	PHG 186-3M-...	384-3M	128	384	PHG 384-3M-...	753-3M	251	753	PHG 753-3M-...
189-3M	63	189	PHG 189-3M-...	390-3M	130	390	PHG 390-3M-...	801-3M	267	801	PHG 801-3M-...
192-3M	64	192	PHG 192-3M-...	396-3M	132	396	PHG 396-3M-...	804-3M	268	804	PHG 804-3M-...
195-3M	65	195	PHG 195-3M-...	399-3M	133	399	PHG 399-3M-...	813-3M	271	813	PHG 813-3M-...
201-3M	67	201	PHG 201-3M-...	420-3M	140	420	PHG 420-3M-...	843-3M	281	843	PHG 843-3M-...
204-3M	68	204	PHG 204-3M-...	423-3M	141	423	PHG 423-3M-...	885-3M	295	885	PHG 885-3M-...
207-3M	69	207	PHG 207-3M-...	426-3M	142	426	PHG 426-3M-...	939-3M	313	939	PHG 939-3M-...
210-3M	70	210	PHG 210-3M-...	447-3M	149	447	PHG 447-3M-...	1125-3M	375	1125	PHG 1125-3M-...
213-3M	71	213	PHG 213-3M-...	459-3M	153	459	PHG 459-3M-...	1209-3M	403	1209	PHG 1209-3M-...
222-3M	74	222	PHG 222-3M-...	471-3M	157	471	PHG 471-3M-...	1245-3M	415	1245	PHG 1245-3M-...
225-3M	75	225	PHG 225-3M-...	474-3M	158	474	PHG 474-3M-...	1263-3M	421	1263	PHG 1263-3M-...
228-3M	76	228	PHG 228-3M-...	477-3M	159	477	PHG 477-3M-...	1344-3M	448	1344	PHG 1344-3M-...
234-3M	78	234	PHG 234-3M-...	480-3M	160	480	PHG 480-3M-...	1401-3M	467	1401	PHG 1401-3M-...
237-3M	79	237	PHG 237-3M-...	483-3M	161	483	PHG 483-3M-...	1569-3M	523	1569	PHG 1569-3M-...
240-3M	80	240	PHG 240-3M-...	486-3M	162	486	PHG 486-3M-...	1800-3M	600	1800	PHG 1800-3M-...
246-3M	82	246	PHG 246-3M-...	492-3M	164	492	PHG 492-3M-...	1950-3M	650	1950	PHG 1950-3M-...
252-3M	84	252	PHG 252-3M-...	495-3M	165	495	PHG 495-3M-...	2160-3M	720	2160	PHG 2160-3M-...
255-3M	85	255	PHG 255-3M-...	501-3M	167	501	PHG 501-3M-...	2388-3M	796	2388	PHG 2388-3M-...
264-3M	88	264	PHG 264-3M-...	510-3M	170	510	PHG 510-3M-...	2640-3M	880	2640	PHG 2640-3M-...
267-3M	89	267	PHG 267-3M-...	513-3M	171	513	PHG 513-3M-...	3000-3M	1000	3000	PHG 3000-3M-...
270-3M	90	270	PHG 270-3M-...	522-3M	174	522	PHG 522-3M-...	3210-3M	1070	3210	PHG 3210-3M-...
276-3M	92	276	PHG 276-3M-...	531-3M	177	531	PHG 531-3M-...	3390-3M	1130	3390	PHG 3390-3M-...
282-3M	94	282	PHG 282-3M-...	537-3M	179	537	PHG 537-3M-...	-	-	-	-
285-3M	95	285	PHG 285-3M-...	558-3M	186	558	PHG 558-3M-...	-	-	-	-

Úplné značení musí obsahovat šířku pásu v mm.

Nabídka obsahuje rovněž nestandardní délky.

Řemenové rukávy se dodávají v různých šířkách. Kontaktujte, prosím, Vašeho zástupce SKF.



Synchronní řemeny HiTD

5M

- ▶ Řemeny
- ▶ Řetězy
- ▶ Spojky
- ▶ Pouzdra a náboje
- ▶ Řetězová kola
- ▶ Řemenice
- ▶ Inteligentní nástroje

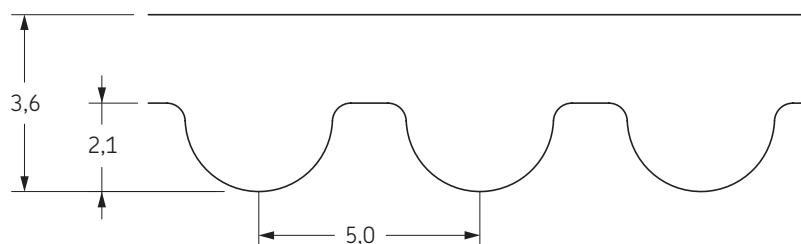

Typ řemenu	Počet zubů	Označení		Typ řemenu	Počet zubů	Označení		Typ řemenu	Počet zubů	Označení	
		Roztečná délka	mm			Roztečná délka	mm			Roztečná délka	mm
180-5M	36	180	PHG 180-5M-...	550-5M	110	550	PHG 550-5M-...	960-5M	192	960	PHG 960-5M-...
200-5M	40	200	PHG 200-5M-...	560-5M	112	560	PHG 560-5M-...	975-5M	195	975	PHG 975-5M-...
210-5M	42	210	PHG 210-5M-...	565-5M	113	565	PHG 565-5M-...	980-5M	196	980	PHG 980-5M-...
215-5M	43	215	PHG 215-5M-...	570-5M	114	570	PHG 570-5M-...	1000-5M	200	1000	PHG 1000-5M-...
225-5M	45	225	PHG 225-5M-...	575-5M	115	575	PHG 575-5M-...	1025-5M	205	1025	PHG 1025-5M-...
235-5M	47	235	PHG 235-5M-...	585-5M	117	585	PHG 585-5M-...	1050-5M	210	1050	PHG 1050-5M-...
250-5M	50	250	PHG 250-5M-...	590-5M	118	590	PHG 590-5M-...	1100-5M	220	1100	PHG 1100-5M-...
255-5M	51	255	PHG 255-5M-...	600-5M	120	600	PHG 600-5M-...	1125-5M	225	1125	PHG 1125-5M-...
265-5M	53	265	PHG 265-5M-...	610-5M	122	610	PHG 610-5M-...	1145-5M	229	1145	PHG 1145-5M-...
280-5M	56	280	PHG 280-5M-...	615-5M	123	615	PHG 615-5M-...	1175-5M	235	1175	PHG 1175-5M-...
285-5M	57	285	PHG 285-5M-...	620-5M	124	620	PHG 620-5M-...	1180-5M	236	1180	PHG 1180-5M-...
295-5M	59	295	PHG 295-5M-...	625-5M	125	625	PHG 625-5M-...	1210-5M	242	1210	PHG 1210-5M-...
300-5M	60	300	PHG 300-5M-...	630-5M	126	630	PHG 630-5M-...	1225-5M	245	1225	PHG 1225-5M-...
305-5M	61	305	PHG 305-5M-...	635-5M	127	635	PHG 635-5M-...	1270-5M	254	1270	PHG 1270-5M-...
310-5M	62	310	PHG 310-5M-...	640-5M	128	640	PHG 640-5M-...	1290-5M	258	1290	PHG 1290-5M-...
320-5M	64	320	PHG 320-5M-...	645-5M	129	645	PHG 645-5M-...	1350-5M	270	1350	PHG 1350-5M-...
325-5M	65	325	PHG 325-5M-...	650-5M	130	650	PHG 650-5M-...	1375-5M	275	1375	PHG 1375-5M-...
330-5M	66	330	PHG 330-5M-...	655-5M	131	655	PHG 655-5M-...	1400-5M	280	1400	PHG 1400-5M-...
340-5M	68	340	PHG 340-5M-...	670-5M	134	670	PHG 670-5M-...	1420-5M	284	1420	PHG 1420-5M-...
350-5M	70	350	PHG 350-5M-...	675-5M	135	675	PHG 675-5M-...	1455-5M	291	1455	PHG 1455-5M-...
365-5M	73	365	PHG 365-5M-...	690-5M	138	690	PHG 690-5M-...	1500-5M	300	1500	PHG 1500-5M-...
370-5M	74	370	PHG 370-5M-...	695-5M	139	695	PHG 695-5M-...	1595-5M	319	1595	PHG 1595-5M-...
375-5M	75	375	PHG 375-5M-...	700-5M	140	700	PHG 700-5M-...	1690-5M	338	1690	PHG 1690-5M-...
385-5M	77	385	PHG 385-5M-...	710-5M	142	710	PHG 710-5M-...	1700-5M	340	1700	PHG 1700-5M-...
395-5M	79	395	PHG 395-5M-...	715-5M	142	710	PHG 715-5M-...	1730-5M	346	1730	PHG 1730-5M-...
400-5M	80	400	PHG 400-5M-...	725-5M	145	725	PHG 725-5M-...	1790-5M	358	1790	PHG 1790-5M-...
405-5M	80	400	PHG 405-5M-...	740-5M	148	740	PHG 740-5M-...	1800-5M	360	1800	PHG 1800-5M-...
410-5M	82	410	PHG 410-5M-...	745-5M	149	745	PHG 745-5M-...	1870-5M	374	1870	PHG 1870-5M-...
420-5M	84	420	PHG 420-5M-...	750-5M	150	750	PHG 750-5M-...	1945-5M	389	1945	PHG 1945-5M-...
425-5M	85	425	PHG 425-5M-...	755-5M	151	755	PHG 755-5M-...	2000-5M	400	2000	PHG 2000-5M-...
430-5M	86	430	PHG 430-5M-...	770-5M	154	770	PHG 770-5M-...	2050-5M	410	2050	PHG 2050-5M-...
440-5M	88	440	PHG 440-5M-...	775-5M	155	775	PHG 775-5M-...	2100-5M	420	2100	PHG 2100-5M-...
445-5M	89	445	PHG 445-5M-...	790-5M	158	790	PHG 790-5M-...	2160-5M	432	2160	PHG 2160-5M-...
450-5M	90	450	PHG 450-5M-...	800-5M	160	800	PHG 800-5M-...	2250-5M	450	2250	PHG 2250-5M-...
460-5M	92	460	PHG 460-5M-...	810-5M	162	810	PHG 810-5M-...	2350-5M	470	2350	PHG 2350-5M-...
470-5M	94	470	PHG 470-5M-...	825-5M	165	825	PHG 825-5M-...	2460-5M	492	2460	PHG 2460-5M-...
475-5M	95	475	PHG 475-5M-...	830-5M	166	830	PHG 830-5M-...	2525-5M	505	2525	PHG 2525-5M-...
480-5M	96	480	PHG 480-5M-...	835-5M	167	835	PHG 835-5M-...	3060-5M	612	3060	PHG 3060-5M-...
490-5M	98	490	PHG 490-5M-...	850-5M	170	850	PHG 850-5M-...	3255-5M	651	3255	PHG 3255-5M-...
500-5M	100	500	PHG 500-5M-...	860-5M	172	860	PHG 860-5M-...	3430-5M	686	3430	PHG 3430-5M-...
505-5M	101	505	PHG 505-5M-...	890-5M	178	890	PHG 890-5M-...	3660-5M	732	3660	PHG 3660-5M-...
520-5M	104	520	PHG 520-5M-...	900-5M	180	900	PHG 900-5M-...	3750-5M	750	3750	PHG 3750-5M-...
525-5M	105	525	PHG 525-5M-...	920-5M	184	920	PHG 920-5M-...	3770-5M	754	3770	PHG 3770-5M-...
530-5M	106	530	PHG 530-5M-...	925-5M	185	925	PHG 925-5M-...	4260-5M	852	4260	PHG 4260-5M-...
535-5M	107	535	PHG 535-5M-...	935-5M	187	935	PHG 935-5M-...	5300-5M	1060	5300	PHG 5300-5M-...
540-5M	108	540	PHG 540-5M-...	950-5M	190	950	PHG 950-5M-...	7000-5M	1400	7000	PHG 7000-5M-...

Úplné značení musí obsahovat šířku pásu v mm.

Nabídka obsahuje rovněž nestandardní délky.

Řemenové rukávy se dodávají v různých šířkách. Kontaktujte, prosím, Vašeho zástupce SKF.



Synchronní řemeny HiTD

8M

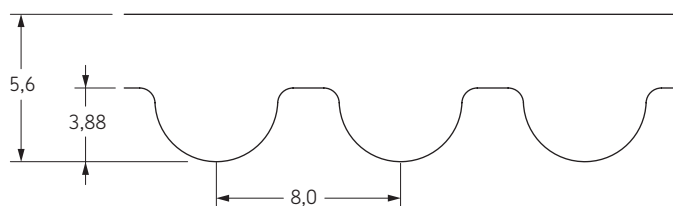
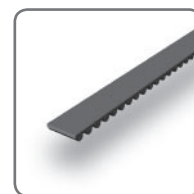

Typ řemenu	Počet zubů	Roztečná délka mm	Označení	Typ řemenu	Počet zubů	Roztečná délka mm	Označení
184-8M	23	184	PHG 184-8M-...	1248-8M	156	1248	PHG 1248-8M-...
288-8M	36	288	PHG 288-8M-...	1256-8M	157	1256	PHG 1256-8M-...
328-8M	41	328	PHG 328-8M-...	1264-8M	158	1264	PHG 1264-8M-...
336-8M	42	336	PHG 336-8M-...	1272-8M	159	1272	PHG 1272-8M-...
368-8M	46	368	PHG 368-8M-...	1280-8M	160	1280	PHG 1280-8M-...
376-8M	47	376	PHG 376-8M-...	1304-8M	163	1304	PHG 1304-8M-...
384-8M	48	384	PHG 384-8M-...	1312-8M	164	1312	PHG 1312-8M-...
400-8M	50	400	PHG 400-8M-...	1328-8M	166	1328	PHG 1328-8M-...
408-8M	51	408	PHG 408-8M-...	1344-8M	168	1344	PHG 1344-8M-...
416-8M	52	416	PHG 416-8M-...	1360-8M	170	1360	PHG 1360-8M-...
424-8M	53	424	PHG 424-8M-...	1392-8M	174	1392	PHG 1392-8M-...
440-8M	55	440	PHG 440-8M-...	1400-8M	175	1400	PHG 1400-8M-...
472-8M	59	472	PHG 472-8M-...	1424-8M	178	1424	PHG 1424-8M-...
480-8M	60	480	PHG 480-8M-...	1440-8M	180	1440	PHG 1440-8M-...
512-8M	64	512	PHG 512-8M-...	1456-8M	182	1456	PHG 1456-8M-...
520-8M	65	520	PHG 520-8M-...	1480-8M	185	1480	PHG 1480-8M-...
536-8M	67	536	PHG 536-8M-...	1512-8M	189	1512	PHG 1512-8M-...
560-8M	70	560	PHG 560-8M-...	1520-8M	190	1520	PHG 1520-8M-...
568-8M	71	568	PHG 568-8M-...	1536-8M	192	1536	PHG 1536-8M-...
576-8M	72	576	PHG 576-8M-...	1552-8M	194	1552	PHG 1552-8M-...
584-8M	73	584	PHG 584-8M-...	1576-8M	197	1576	PHG 1576-8M-...
600-8M	75	600	PHG 600-8M-...	1600-8M	200	1600	PHG 1600-8M-...
624-8M	78	624	PHG 624-8M-...	1648-8M	206	1648	PHG 1648-8M-...
632-8M	79	632	PHG 632-8M-...	1680-8M	210	1680	PHG 1680-8M-...
640-8M	80	640	PHG 640-8M-...	1696-8M	212	1696	PHG 1696-8M-...
656-8M	82	656	PHG 656-8M-...	1728-8M	216	1728	PHG 1728-8M-...
680-8M	85	680	PHG 680-8M-...	1760-8M	220	1760	PHG 1760-8M-...
688-8M	86	688	PHG 688-8M-...	1784-8M	223	1784	PHG 1784-8M-...
696-8M	87	696	PHG 696-8M-...	1792-8M	224	1792	PHG 1792-8M-...
712-8M	89	712	PHG 712-8M-...	1800-8M	225	1800	PHG 1800-8M-...
720-8M	90	720	PHG 720-8M-...	1856-8M	232	1856	PHG 1856-8M-...
728-8M	91	728	PHG 728-8M-...	1896-8M	237	1896	PHG 1896-8M-...
760-8M	95	760	PHG 760-8M-...	1904-8M	238	1904	PHG 1904-8M-...
776-8M	97	776	PHG 776-8M-...	1936-8M	242	1936	PHG 1936-8M-...
792-8M	99	792	PHG 792-8M-...	2000-8M	250	2000	PHG 2000-8M-...
800-8M	100	800	PHG 800-8M-...	2080-8M	260	2080	PHG 2080-8M-...
816-8M	102	816	PHG 816-8M-...	2096-8M	262	2096	PHG 2096-8M-...
824-8M	103	824	PHG 824-8M-...	2104-8M	263	2104	PHG 2104-8M-...
840-8M	105	840	PHG 840-8M-...	2136-8M	267	2136	PHG 2136-8M-...
856-8M	107	856	PHG 856-8M-...	2208-8M	276	2208	PHG 2208-8M-...
864-8M	108	864	PHG 864-8M-...	2240-8M	280	2240	PHG 2240-8M-...
872-8M	109	872	PHG 872-8M-...	2304-8M	288	2304	PHG 2304-8M-...
880-8M	110	880	PHG 880-8M-...	2328-8M	291	2328	PHG 2328-8M-...
896-8M	112	896	PHG 896-8M-...	2392-8M	299	2392	PHG 2392-8M-...
920-8M	115	920	PHG 920-8M-...	2400-8M	300	2400	PHG 2400-8M-...
928-8M	116	928	PHG 928-8M-...	2504-8M	313	2504	PHG 2504-8M-...
952-8M	119	952	PHG 952-8M-...	2600-8M	325	2600	PHG 2600-8M-...
960-8M	120	960	PHG 960-8M-...	2736-8M	342	2736	PHG 2736-8M-...
968-8M	121	968	PHG 968-8M-...	2800-8M	350	2800	PHG 2800-8M-...
976-8M	122	976	PHG 976-8M-...	3048-8M	381	3048	PHG 3048-8M-...
1000-8M	125	1000	PHG 1000-8M-...	3120-8M	390	3120	PHG 3120-8M-...
1016-8M	127	1016	PHG 1016-8M-...	3168-8M	396	3168	PHG 3168-8M-...
1040-8M	130	1040	PHG 1040-8M-...	3200-8M	400	3200	PHG 3200-8M-...
1056-8M	132	1056	PHG 1056-8M-...	3280-8M	410	3280	PHG 3280-8M-...
1080-8M	135	1080	PHG 1080-8M-...	3400-8M	425	3400	PHG 3400-8M-...
1104-8M	138	1104	PHG 1104-8M-...	3600-8M	450	3600	PHG 3600-8M-...
1120-8M	140	1120	PHG 1120-8M-...	4000-8M	500	4000	PHG 4000-8M-...
1128-8M	141	1128	PHG 1128-8M-...	4200-8M	525	4200	PHG 4200-8M-...
1136-8M	142	1136	PHG 1136-8M-...	4400-8M	550	4400	PHG 4400-8M-...
1152-8M	144	1152	PHG 1152-8M-...	5120-8M	640	5120	PHG 5120-8M-...
1168-8M	146	1168	PHG 1168-8M-...	5600-8M	700	5600	PHG 5600-8M-...
1184-8M	148	1184	PHG 1184-8M-...	5960-8M	745	5960	PHG 5960-8M-...
1200-8M	150	1200	PHG 1200-8M-...	6600-8M	825	6600	PHG 6600-8M-...
1216-8M	152	1216	PHG 1216-8M-...	6880-8M	860	6880	PHG 6880-8M-...

Úplné značení musí obsahovat šířku pásu v mm.

Nabídka obsahuje rovněž nestandardní délky.

Řemenové rukávy se dodávají v různých šířkách. Kontaktujte, prosím, Vašeho zástupce SKF.

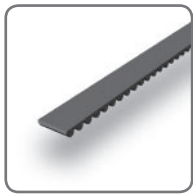

Synchronní řemeny HiTD

14M

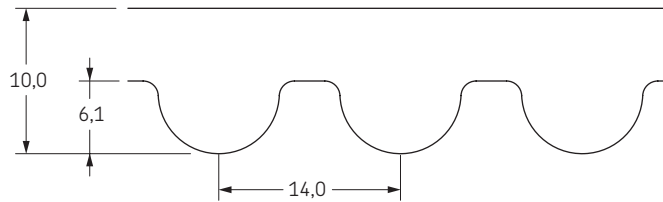

- ▶ Řemeny
- ▶ Řetězy
- ▶ Spojky
- ▶ Pouzdra a náboje
- ▶ Řetězová kola
- ▶ Řemenice
- ▶ Inteligentní nástroje

Typ řemenu	Počet zubů	Roztečná délka	Označení	Typ řemenu	Počet zubů	Roztečná délka	Označení
		mm				mm	
966-14M	69	966	PHG 966-14M-...	1820-14M	130	1820	PHG 1820-14M-...
1036-14M	74	1036	PHG 1036-14M-...	1890-14M	135	1890	PHG 1890-14M-...
1064-14M	76	1064	PHG 1064-14M-...	1932-14M	138	1932	PHG 1932-14M-...
1092-14M	78	1092	PHG 1092-14M-...	1960-14M	140	1960	PHG 1960-14M-...
1120-14M	80	1120	PHG 1120-14M-...	2002-14M	143	2002	PHG 2002-14M-...
1190-14M	85	1190	PHG 1190-14M-...	2100-14M	150	2100	PHG 2100-14M-...
1246-14M	89	1246	PHG 1246-14M-...	2240-14M	160	2240	PHG 2240-14M-...
1260-14M	90	1260	PHG 1260-14M-...	2310-14M	165	2310	PHG 2310-14M-...
1288-14M	92	1288	PHG 1288-14M-...	2450-14M	175	2450	PHG 2450-14M-...
1316-14M	94	1316	PHG 1316-14M-...	2590-14M	185	2590	PHG 2590-14M-...
1344-14M	96	1344	PHG 1344-14M-...	2800-14M	200	2800	PHG 2800-14M-...
1400-14M	100	1400	PHG 1400-14M-...	3108-14M	222	3108	PHG 3108-14M-...
1414-14M	101	1414	PHG 1414-14M-...	3150-14M	225	3150	PHG 3150-14M-...
1442-14M	103	1442	PHG 1442-14M-...	3304-14M	236	3304	PHG 3304-14M-...
1456-14M	104	1456	PHG 1456-14M-...	3360-14M	240	3360	PHG 3360-14M-...
1470-14M	105	1470	PHG 1470-14M-...	3500-14M	250	3500	PHG 3500-14M-...
1512-14M	108	1512	PHG 1512-14M-...	3850-14M	275	3850	PHG 3850-14M-...
1540-14M	110	1540	PHG 1540-14M-...	4326-14M	309	4326	PHG 4326-14M-...
1568-14M	112	1568	PHG 1568-14M-...	4578-14M	327	4578	PHG 4578-14M-...
1610-14M	115	1610	PHG 1610-14M-...	4760-14M	340	4760	PHG 4760-14M-...
1652-14M	118	1652	PHG 1652-14M-...	4956-14M	354	4956	PHG 4956-14M-...
1750-14M	125	1750	PHG 1750-14M-...	5040-14M	360	5040	PHG 5040-14M-...
1764-14M	126	1764	PHG 1764-14M-...	6160-14M	440	6160	PHG 6160-14M-...
1778-14M	127	1778	PHG 1778-14M-...	6860-14M	490	6860	PHG 6860-14M-...
1806-14M	129	1806	PHG 1806-14M-...	-	-	-	-

Úplné značení musí obsahovat šířku pásu v mm.

Nabídka obsahuje rovněž nestandardní délky.

Řemeny velikosti 20M jsou k dispozici ve vybraných délkách.

Řemenové rukávy se dodávají v různých šířkách. Kontaktujte, prosím, Vašeho zástupce SKF.



Oboustranné synchronní řemeny HiTD

D-5M

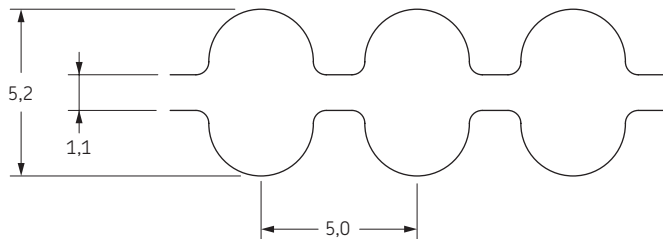
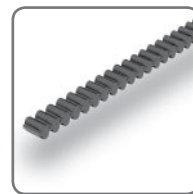

Typ řemenu	Počet zubů na jedné straně	Roztečná délka	Označení	Typ řemenu	Počet zubů na jedné straně	Roztečná délka	Označení
		mm				mm	
DA-500-5M	100	500	PHG DA-500-5M-...	DA-775-5M	155	775	PHG DA-775-5M-...
DA-505-5M	101	505	PHG DA-505-5M-...	DA-790-5M	158	790	PHG DA-790-5M-...
DA-520-5M	104	520	PHG DA-520-5M-...	DA-800-5M	160	800	PHG DA-800-5M-...
DA-525-5M	105	525	PHG DA-525-5M-...	DA-810-5M	162	810	PHG DA-810-5M-...
DA-530-5M	106	530	PHG DA-530-5M-...	DA-825-5M	165	825	PHG DA-825-5M-...
DA-535-5M	107	535	PHG DA-535-5M-...	DA-830-5M	166	830	PHG DA-830-5M-...
DA-540-5M	108	540	PHG DA-540-5M-...	DA-835-5M	167	835	PHG DA-835-5M-...
DA-550-5M	110	550	PHG DA-550-5M-...	DA-850-5M	170	850	PHG DA-850-5M-...
DA-560-5M	112	560	PHG DA-560-5M-...	DA-860-5M	172	860	PHG DA-860-5M-...
DA-565-5M	113	565	PHG DA-565-5M-...	DA-890-5M	178	890	PHG DA-890-5M-...
DA-570-5M	114	570	PHG DA-570-5M-...	DA-900-5M	180	900	PHG DA-900-5M-...
DA-575-5M	115	575	PHG DA-575-5M-...	DA-920-5M	184	920	PHG DA-920-5M-...
DA-585-5M	117	585	PHG DA-585-5M-...	DA-925-5M	185	925	PHG DA-925-5M-...
DA-590-5M	118	590	PHG DA-590-5M-...	DA-935-5M	187	935	PHG DA-935-5M-...
DA-600-5M	120	600	PHG DA-600-5M-...	DA-950-5M	190	950	PHG DA-950-5M-...
DA-610-5M	122	610	PHG DA-610-5M-...	DA-960-5M	192	960	PHG DA-960-5M-...
DA-615-5M	123	615	PHG DA-615-5M-...	DA-975-5M	195	975	PHG DA-975-5M-...
DA-620-5M	124	620	PHG DA-620-5M-...	DA-980-5M	195	975	PHG DA-980-5M-...
DA-625-5M	125	625	PHG DA-625-5M-...	DA-1000-5M	200	1000	PHG DA-1000-5M-...
DA-630-5M	126	630	PHG DA-630-5M-...	DA-1025-5M	205	1025	PHG DA-1025-5M-...
DA-635-5M	127	635	PHG DA-635-5M-...	DA-1050-5M	210	1050	PHG DA-1050-5M-...
DA-640-5M	128	640	PHG DA-640-5M-...	DA-1100-5M	220	1100	PHG DA-1100-5M-...
DA-645-5M	129	645	PHG DA-645-5M-...	DA-1125-5M	225	1125	PHG DA-1125-5M-...
DA-650-5M	130	650	PHG DA-650-5M-...	DA-1145-5M	229	1145	PHG DA-1145-5M-...
DA-655-5M	131	655	PHG DA-655-5M-...	DA-1175-5M	235	1175	PHG DA-1175-5M-...
DA-670-5M	134	670	PHG DA-670-5M-...	DA-1180-5M	236	1180	PHG DA-1180-5M-...
DA-675-5M	135	675	PHG DA-675-5M-...	DA-1210-5M	242	1210	PHG DA-1210-5M-...
DA-690-5M	138	690	PHG DA-690-5M-...	DA-1225-5M	245	1225	PHG DA-1225-5M-...
DA-695-5M	139	695	PHG DA-695-5M-...	DA-1270-5M	254	1270	PHG DA-1270-5M-...
DA-700-5M	140	700	PHG DA-700-5M-...	DA-1290-5M	258	1290	PHG DA-1290-5M-...
DA-710-5M	142	710	PHG DA-710-5M-...	DA-1350-5M	270	1350	PHG DA-1350-5M-...
DA-715-5M	142	710	PHG DA-715-5M-...	DA-1375-5M	275	1375	PHG DA-1375-5M-...
DA-725-5M	145	725	PHG DA-725-5M-...	DA-1400-5M	280	1400	PHG DA-1400-5M-...
DA-740-5M	148	740	PHG DA-740-5M-...	DA-1420-5M	284	1420	PHG DA-1420-5M-...
DA-745-5M	149	745	PHG DA-745-5M-...	DA-1455-5M	291	1455	PHG DA-1455-5M-...
DA-750-5M	150	750	PHG DA-750-5M-...	DA-1500-5M	300	1500	PHG DA-1500-5M-...
DA-755-5M	151	755	PHG DA-755-5M-...	DA-1595-5M	319	1595	PHG DA-1595-5M-...
DA-770-5M	154	770	PHG DA-770-5M-...	DA-1690-5M	338	1690	PHG DA-1690-5M-...

Úplné značení musí obsahovat šířku pásu v mm.

Nabídka obsahuje rovněž nestandardní délky.

Oboustranné pásy HiTD jsou nabízeny se symetrickými (DA) a asymetrickými (DB) profily zubů. Pokud není uvedeno jinak, je dodáván pás se zuby se symetrickým profilem (DA).

Řemenové rukávy se dodávají v různých šířkách. Kontaktujte, prosím, Vašeho zástupce SKF.

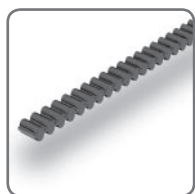

Oboustranné synchronní řemeny HiTD

D-8M

- ▶ Řemeny
- ▶ Řetězy
- ▶ Spojky
- ▶ Pouzdra a náboje
- ▶ Řetězová kola
- ▶ Řemenice
- ▶ Inteligentní nástroje

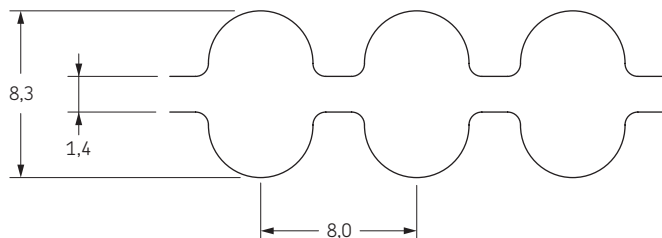

Typ řemenu	Počet zubů na jedné straně	Roztečná délka	Označení	Typ řemenu	Počet zubů na jedné straně	Roztečná délka	Označení
		mm				mm	
DA-512-8M	64	512	PHG DA-512-8M-...	DA-1328-8M	166	1328	PHG DA-1328-8M-...
DA-520-8M	65	520	PHG DA-520-8M-...	DA-1344-8M	168	1344	PHG DA-1344-8M-...
DA-536-8M	67	536	PHG DA-536-8M-...	DA-1360-8M	170	1360	PHG DA-1360-8M-...
DA-560-8M	70	560	PHG DA-560-8M-...	DA-1392-8M	174	1392	PHG DA-1392-8M-...
DA-568-8M	71	568	PHG DA-568-8M-...	DA-1400-8M	175	1400	PHG DA-1400-8M-...
DA-576-8M	72	576	PHG DA-576-8M-...	DA-1424-8M	178	1424	PHG DA-1424-8M-...
DA-584-8M	73	584	PHG DA-584-8M-...	DA-1440-8M	180	1440	PHG DA-1440-8M-...
DA-600-8M	75	600	PHG DA-600-8M-...	DA-1456-8M	182	1456	PHG DA-1456-8M-...
DA-624-8M	78	624	PHG DA-624-8M-...	DA-1480-8M	185	1480	PHG DA-1480-8M-...
DA-632-8M	79	632	PHG DA-632-8M-...	DA-1512-8M	189	1512	PHG DA-1512-8M-...
DA-640-8M	80	640	PHG DA-640-8M-...	DA-1520-8M	190	1520	PHG DA-1520-8M-...
DA-656-8M	82	656	PHG DA-656-8M-...	DA-1536-8M	192	1536	PHG DA-1536-8M-...
DA-680-8M	85	680	PHG DA-680-8M-...	DA-1552-8M	194	1552	PHG DA-1552-8M-...
DA-688-8M	86	688	PHG DA-688-8M-...	DA-1576-8M	197	1576	PHG DA-1576-8M-...
DA-696-8M	87	696	PHG DA-696-8M-...	DA-1600-8M	200	1600	PHG DA-1600-8M-...
DA-712-8M	89	712	PHG DA-712-8M-...	DA-1648-8M	206	1648	PHG DA-1648-8M-...
DA-720-8M	90	720	PHG DA-720-8M-...	DA-1680-8M	210	1680	PHG DA-1680-8M-...
DA-728-8M	91	728	PHG DA-728-8M-...	DA-1696-8M	212	1696	PHG DA-1696-8M-...
DA-760-8M	95	760	PHG DA-760-8M-...	DA-1728-8M	216	1728	PHG DA-1728-8M-...
DA-776-8M	97	776	PHG DA-776-8M-...	DA-1760-8M	220	1760	PHG DA-1760-8M-...
DA-792-8M	99	792	PHG DA-792-8M-...	DA-1784-8M	223	1784	PHG DA-1784-8M-...
DA-800-8M	100	800	PHG DA-800-8M-...	DA-1792-8M	224	1792	PHG DA-1792-8M-...
DA-816-8M	102	816	PHG DA-816-8M-...	DA-1800-8M	225	1800	PHG DA-1800-8M-...
DA-824-8M	103	824	PHG DA-824-8M-...	DA-1856-8M	232	1856	PHG DA-1856-8M-...
DA-840-8M	105	840	PHG DA-840-8M-...	DA-1896-8M	237	1896	PHG DA-1896-8M-...
DA-856-8M	107	856	PHG DA-856-8M-...	DA-1904-8M	238	1904	PHG DA-1904-8M-...
DA-864-8M	108	864	PHG DA-864-8M-...	DA-1936-8M	242	1936	PHG DA-1936-8M-...
DA-872-8M	109	872	PHG DA-872-8M-...	DA-2000-8M	250	2000	PHG DA-2000-8M-...
DA-880-8M	110	880	PHG DA-880-8M-...	DA-2080-8M	260	2080	PHG DA-2080-8M-...
DA-896-8M	112	896	PHG DA-896-8M-...	DA-2096-8M	262	2096	PHG DA-2096-8M-...
DA-920-8M	115	920	PHG DA-920-8M-...	DA-2104-8M	263	2104	PHG DA-2104-8M-...
DA-928-8M	116	928	PHG DA-928-8M-...	DA-2136-8M	267	2136	PHG DA-2136-8M-...
DA-952-8M	119	952	PHG DA-952-8M-...	DA-2208-8M	276	2208	PHG DA-2208-8M-...
DA-960-8M	120	960	PHG DA-960-8M-...	DA-2240-8M	280	2240	PHG DA-2240-8M-...
DA-968-8M	121	968	PHG DA-968-8M-...	DA-2304-8M	288	2304	PHG DA-2304-8M-...
DA-976-8M	122	976	PHG DA-976-8M-...	DA-2328-8M	291	2328	PHG DA-2328-8M-...
DA-1000-8M	125	1000	PHG DA-1000-8M-...	DA-2392-8M	299	2392	PHG DA-2392-8M-...
DA-1016-8M	127	1016	PHG DA-1016-8M-...	DA-2400-8M	300	2400	PHG DA-2400-8M-...
DA-1040-8M	130	1040	PHG DA-1040-8M-...	DA-2504-8M	313	2504	PHG DA-2504-8M-...
DA-1056-8M	132	1056	PHG DA-1056-8M-...	DA-2600-8M	325	2600	PHG DA-2600-8M-...
DA-1080-8M	135	1080	PHG DA-1080-8M-...	DA-2736-8M	342	2736	PHG DA-2736-8M-...
DA-1104-8M	138	1104	PHG DA-1104-8M-...	DA-2800-8M	350	2800	PHG DA-2800-8M-...
DA-1120-8M	140	1120	PHG DA-1120-8M-...	DA-3048-8M	381	3048	PHG DA-3048-8M-...
DA-1128-8M	141	1128	PHG DA-1128-8M-...	DA-3120-8M	390	3120	PHG DA-3120-8M-...
DA-1136-8M	142	1136	PHG DA-1136-8M-...	DA-3168-8M	396	3168	PHG DA-3168-8M-...
DA-1152-8M	144	1152	PHG DA-1152-8M-...	DA-3200-8M	400	3200	PHG DA-3200-8M-...
DA-1168-8M	146	1168	PHG DA-1168-8M-...	DA-3280-8M	410	3280	PHG DA-3280-8M-...
DA-1184-8M	148	1184	PHG DA-1184-8M-...	DA-3400-8M	425	3400	PHG DA-3400-8M-...
DA-1200-8M	150	1200	PHG DA-1200-8M-...	DA-3600-8M	450	3600	PHG DA-3600-8M-...
DA-1216-8M	152	1216	PHG DA-1216-8M-...	DA-4000-8M	500	4000	PHG DA-4000-8M-...
DA-1248-8M	156	1248	PHG DA-1248-8M-...	DA-4200-8M	525	4200	PHG DA-4200-8M-...
DA-1256-8M	157	1256	PHG DA-1256-8M-...	DA-4400-8M	550	4400	PHG DA-4400-8M-...
DA-1264-8M	158	1264	PHG DA-1264-8M-...	DA-5120-8M	640	5120	PHG DA-5120-8M-...
DA-1272-8M	159	1272	PHG DA-1272-8M-...	DA-5600-8M	700	5600	PHG DA-5600-8M-...
DA-1280-8M	160	1280	PHG DA-1280-8M-...	DA-5960-8M	745	5960	PHG DA-5960-8M-...
DA-1304-8M	163	1304	PHG DA-1304-8M-...	DA-6600-8M	825	6600	PHG DA-6600-8M-...
DA-1312-8M	164	1312	PHG DA-1312-8M-...	DA-6880-8M	860	6880	PHG DA-6880-8M-...

Úplné značení musí obsahovat šířku pásu v mm.

Nabídka obsahuje rovněž nestandardní délky.

Oboustranné pásy HiTD jsou nabízeny se symetrickými (DA) a asymetrickými (DB) profily zubů. Pokud není uvedeno jinak, je dodáván pás se zuby se symetrickým profilem (DA).

Řemenové rukávy se dodávají v různých šířkách. Kontaktujte, prosím, Vašeho zástupce SKF.



Oboustranné synchronní řemeny HiTD

D-14M

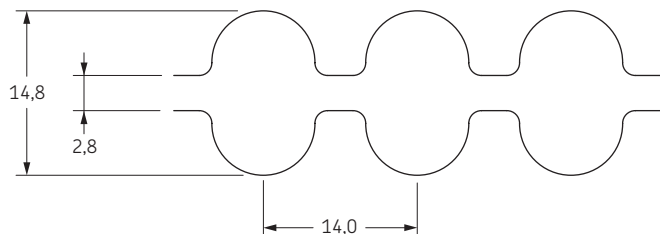
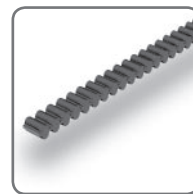

Typ řemenu	Počet zubů na jedné straně	Roztečná délka mm	Označení	Typ řemenu	Počet zubů na jedné straně	Roztečná délka mm	Označení
DA-1764-14M	126	1764	PHG DA-1764-14M-...	DA-2800-14M	200	2800	PHG DA-2800-14M-...
DA-1750-14M	125	1750	PHG DA-1750-14M-...	DA-3108-14M	222	3108	PHG DA-3108-14M-...
DA-1764-14M	126	1764	PHG DA-1764-14M-...	DA-3150-14M	225	3150	PHG DA-3150-14M-...
DA-1778-14M	127	1778	PHG DA-1778-14M-...	DA-3304-14M	236	3304	PHG DA-3304-14M-...
DA-1806-14M	129	1806	PHG DA-1806-14M-...	DA-3360-14M	240	3360	PHG DA-3360-14M-...
DA-1820-14M	130	1820	PHG DA-1820-14M-...	DA-3500-14M	250	3500	PHG DA-3500-14M-...
DA-1890-14M	135	1890	PHG DA-1890-14M-...	DA-3850-14M	275	3850	PHG DA-3850-14M-...
DA-1932-14M	138	1932	PHG DA-1932-14M-...	DA-4326-14M	309	4326	PHG DA-4326-14M-...
DA-1960-14M	140	1960	PHG DA-1960-14M-...	DA-4578-14M	327	4578	PHG DA-4578-14M-...
DA-2002-14M	143	2002	PHG DA-2002-14M-...	DA-4760-14M	340	4760	PHG DA-4760-14M-...
DA-2100-14M	150	2100	PHG DA-2100-14M-...	DA-4956-14M	354	4956	PHG DA-4956-14M-...
DA-2240-14M	160	2240	PHG DA-2240-14M-...	DA-5040-14M	360	5040	PHG DA-5040-14M-...
DA-2310-14M	165	2310	PHG DA-2310-14M-...	DA-6160-14M	440	6160	PHG DA-6160-14M-...
DA-2450-14M	175	2450	PHG DA-2450-14M-...	DA-6860-14M	490	6860	PHG DA-6860-14M-...
DA-2590-14M	185	2590	PHG DA-2590-14M-...	-	-	-	-

Úplné značení musí obsahovat šířku pásu v mm.

Nabídka obsahuje rovněž nestandardní délky.

Oboustranné pásy HiTD jsou nabízeny se symetrickými (DA) a asymetrickými (DB) profily zubů.

Pokud není uvedeno jinak, je dodáván pás se zuby se symetrickým profilem (DA).

Řemenové rukávy se dodávají v různých šířkách. Kontaktujte, prosím, Vašeho zástupce SKF.

Metrické ozubené řemeny

T2.5

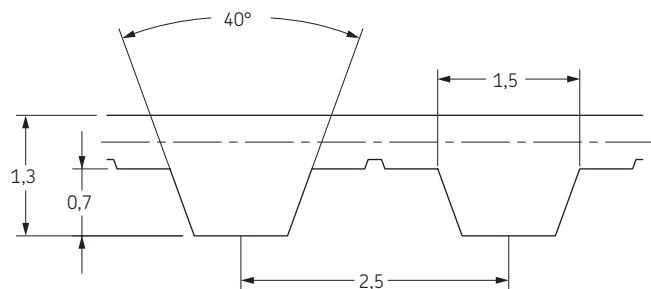

Typ řemenu	Počet zubů na jedné straně	Roztečná délka mm	Označení	Typ řemenu	Počet zubů na jedné straně	Roztečná délka mm	Označení
T2,5-102,5	41	102,5	PHG T2,5-102,5-...	T2,5-420	168	420,0	PHG T2,5-420-...
T2,5-120	48	120,0	PHG T2,5-120-...	T2,5-470	188	470,0	PHG T2,5-470-...
T2,5-145	58	145,0	PHG T2,5-145-...	T2,5-480	192	480,0	PHG T2,5-480-...
T2,5-150	60	150,0	PHG T2,5-150-...	T2,5-500	200	500,0	PHG T2,5-500-...
T2,5-160	64	160,0	PHG T2,5-160-...	T2,5-540	216	540,0	PHG T2,5-540-...
T2,5-165	66	165,0	PHG T2,5-165-...	T2,5-620	248	620,0	PHG T2,5-620-...
T2,5-177,5	71	177,5	PHG T2,5-177,5-...	T2,5-635	254	635,0	PHG T2,5-635-...
T2,5-187,5	75	187,5	PHG T2,5-187,5-...	T2,5-690	276	690,0	PHG T2,5-690-...
T2,5-200	80	200,0	PHG T2,5-200-...	T2,5-705	282	705,0	PHG T2,5-705-...
T2,5-230	92	230,0	PHG T2,5-230-...	T2,5-787,5	315	787,5	PHG T2,5-787,5-...
T2,5-245	98	245,0	PHG T2,5-245-...	T2,5-905	362	905,0	PHG T2,5-905-...
T2,5-265	106	265,0	PHG T2,5-265-...	T2,5-975	390	975,0	PHG T2,5-975-...
T2,5-285	114	285,0	PHG T2,5-285-...	T2,5-1040	416	1040,0	PHG T2,5-1040-...
T2,5-300	120	300,0	PHG T2,5-300-...	T2,5-1090	436	1090,0	PHG T2,5-1090-...
T2,5-317,5	127	317,5	PHG T2,5-317,5-...	T2,5-1095	438	1095,0	PHG T2,5-1095-...
T2,5-330	132	330,0	PHG T2,5-330-...	T2,5-1127,5	451	1127,5	PHG T2,5-1127,5-...
T2,5-335	134	335,0	PHG T2,5-335-...	T2,5-1295	518	1295,0	PHG T2,5-1295-...
T2,5-380	152	380,0	PHG T2,5-380-...	T2,5-1345	538	1345,0	PHG T2,5-1345-...
T2,5-410	164	410,0	PHG T2,5-410-...	-	-	-	-

Úplné značení musí obsahovat šířku pásu v mm.

Nabídka obsahuje rovněž nestandardní délky.

Řemenové rukávy se dodávají v různých šířkách. Kontaktujte, prosím, Vašeho zástupce SKF.



Metrické ozubené řemeny

T5

- ▶ Řemeny
- ▶ Řetězy
- ▶ Spojky
- ▶ Pouzdra a náboje
- ▶ Řetězová kola
- ▶ Řemenice
- ▶ Inteligentní nástroje

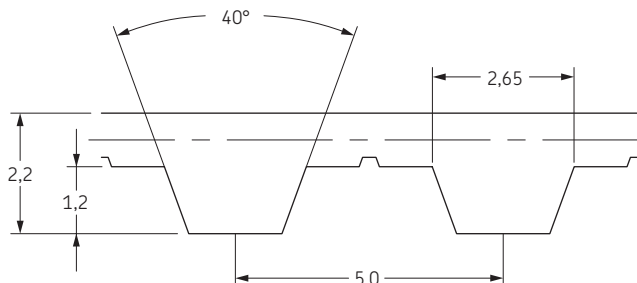

Typ řemenu	Počet zubů	Roztečná délka	Označení	Typ řemenu	Počet zubů	Roztečná délka	Označení
		mm				mm	
T5-115	23	115	PHG T5-115-...	T5-690	138	690	PHG T5-690-...
T5-150	30	150	PHG T5-150-...	T5-700	140	700	PHG T5-700-...
T5-165	33	165	PHG T5-165-...	T5-710	142	710	PHG T5-710-...
T5-185	37	185	PHG T5-185-...	T5-720	144	720	PHG T5-720-...
T5-200	40	200	PHG T5-200-...	T5-725	145	725	PHG T5-725-...
T5-210	42	210	PHG T5-210-...	T5-740	148	740	PHG T5-740-...
T5-215	43	215	PHG T5-215-...	T5-750	150	750	PHG T5-750-...
T5-220	44	220	PHG T5-220-...	T5-780	156	780	PHG T5-780-...
T5-225	45	225	PHG T5-225-...	T5-800	160	800	PHG T5-800-...
T5-240	48	240	PHG T5-240-...	T5-805	161	805	PHG T5-805-...
T5-250	50	250	PHG T5-250-...	T5-810	162	810	PHG T5-810-...
T5-255	51	255	PHG T5-255-...	T5-815	163	815	PHG T5-815-...
T5-260	52	260	PHG T5-260-...	T5-840	168	840	PHG T5-840-...
T5-270	54	270	PHG T5-270-...	T5-850	170	850	PHG T5-850-...
T5-275	55	275	PHG T5-275-...	T5-860	172	860	PHG T5-860-...
T5-280	56	280	PHG T5-280-...	T5-900	180	900	PHG T5-900-...
T5-295	59	295	PHG T5-295-...	T5-940	188	940	PHG T5-940-...
T5-300	60	300	PHG T5-300-...	T5-990	198	990	PHG T5-990-...
T5-305	61	305	PHG T5-305-...	T5-995	199	995	PHG T5-995-...
T5-310	62	310	PHG T5-310-...	T5-1000	200	1000	PHG T5-1000-...
T5-325	65	325	PHG T5-325-...	T5-1020	204	1020	PHG T5-1020-...
T5-330	66	330	PHG T5-330-...	T5-1030	206	1030	PHG T5-1030-...
T5-340	68	340	PHG T5-340-...	T5-1045	209	1045	PHG T5-1045-...
T5-350	70	350	PHG T5-350-...	T5-1050	210	1050	PHG T5-1050-...
T5-355	71	355	PHG T5-355-...	T5-1060	212	1060	PHG T5-1060-...
T5-365	73	365	PHG T5-365-...	T5-1075	215	1075	PHG T5-1075-...
T5-375	75	375	PHG T5-375-...	T5-1100	220	1100	PHG T5-1100-...
T5-390	78	390	PHG T5-390-...	T5-1120	224	1120	PHG T5-1120-...
T5-400	80	400	PHG T5-400-...	T5-1140	228	1140	PHG T5-1140-...
T5-410	82	410	PHG T5-410-...	T5-1200	240	1200	PHG T5-1200-...
T5-420	84	420	PHG T5-420-...	T5-1215	243	1215	PHG T5-1215-...
T5-450	90	450	PHG T5-450-...	T5-1260	252	1260	PHG T5-1260-...
T5-455	91	455	PHG T5-455-...	T5-1300	260	1300	PHG T5-1300-...
T5-475	95	475	PHG T5-475-...	T5-1380	276	1380	PHG T5-1380-...
T5-480	96	480	PHG T5-480-...	T5-1390	278	1390	PHG T5-1390-...
T5-500	100	500	PHG T5-500-...	T5-1415	283	1415	PHG T5-1415-...
T5-505	101	505	PHG T5-505-...	T5-1520	304	1520	PHG T5-1520-...
T5-510	102	510	PHG T5-510-...	T5-1760	352	1760	PHG T5-1760-...
T5-525	105	525	PHG T5-525-...	T5-1800	360	1800	PHG T5-1800-...
T5-545	109	545	PHG T5-545-...	T5-1880	376	1880	PHG T5-1880-...
T5-550	110	550	PHG T5-550-...	T5-1900	380	1900	PHG T5-1900-...
T5-560	112	560	PHG T5-560-...	T5-1940	388	1940	PHG T5-1940-...
T5-570	114	570	PHG T5-570-...	T5-1960	392	1960	PHG T5-1960-...
T5-575	115	575	PHG T5-575-...	T5-2120	424	2120	PHG T5-2120-...
T5-600	120	600	PHG T5-600-...	T5-2160	432	2160	PHG T5-2160-...
T5-610	122	610	PHG T5-610-...	T5-2220	444	2220	PHG T5-2220-...
T5-620	124	620	PHG T5-620-...	T5-2260	452	2260	PHG T5-2260-...
T5-630	126	630	PHG T5-630-...	T5-2280	456	2280	PHG T5-2280-...
T5-635	127	635	PHG T5-635-...	T5-3060	612	3060	PHG T5-3060-...
T5-650	130	650	PHG T5-650-...	T5-3255	651	3255	PHG T5-3255-...
T5-665	133	665	PHG T5-665-...	T5-3540	708	3540	PHG T5-3540-...
T5-675	135	675	PHG T5-675-...	T5-3750	750	3750	PHG T5-3750-...
T5-685	137	685	PHG T5-685-...	T5-4075	815	4075	PHG T5-4075-...

Úplné značení musí obsahovat šířku pásu v mm.

Nabídka obsahuje rovněž nestandardní délky.

Řemenové rukávy se dodávají v různých šířkách. Kontaktujte, prosím, Vašeho zástupce SKF.



Metrické ozubené řemeny

T10

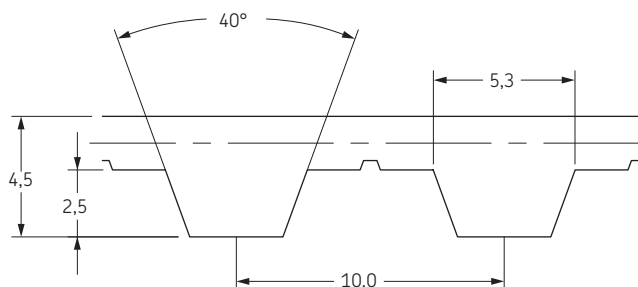
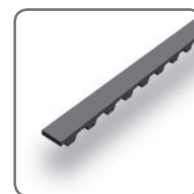

Typ řemenu	Počet zubů	Roztečná délka	Označení	Typ řemenu	Počet zubů	Roztečná délka	Označení
		mm				mm	
T10-260	26	260	PHG T10-260-...	T10-1420	142	1420	PHG T10-1420-...
T10-320	32	320	PHG T10-320-...	T10-1440	144	1440	PHG T10-1440-...
T10-340	34	340	PHG T10-340-...	T10-1450	145	1450	PHG T10-1450-...
T10-370	37	370	PHG T10-370-...	T10-1460	146	1460	PHG T10-1460-...
T10-400	40	400	PHG T10-400-...	T10-1480	148	1480	PHG T10-1480-...
T10-410	41	410	PHG T10-410-...	T10-1500	150	1500	PHG T10-1500-...
T10-440	44	440	PHG T10-440-...	T10-1520	152	1520	PHG T10-1520-...
T10-450	45	450	PHG T10-450-...	T10-1560	156	1560	PHG T10-1560-...
T10-460	46	460	PHG T10-460-...	T10-1600	160	1600	PHG T10-1600-...
T10-480	48	480	PHG T10-480-...	T10-1610	161	1610	PHG T10-1610-...
T10-500	50	500	PHG T10-500-...	T10-1640	164	1640	PHG T10-1640-...
T10-530	53	530	PHG T10-530-...	T10-1690	169	1690	PHG T10-1690-...
T10-540	54	540	PHG T10-540-...	T10-1700	170	1700	PHG T10-1700-...
T10-550	55	550	PHG T10-550-...	T10-1750	175	1750	PHG T10-1750-...
T10-560	56	560	PHG T10-560-...	T10-1780	178	1780	PHG T10-1780-...
T10-580	58	580	PHG T10-580-...	T10-1800	180	1800	PHG T10-1800-...
T10-600	60	600	PHG T10-600-...	T10-1860	186	1860	PHG T10-1860-...
T10-610	61	610	PHG T10-610-...	T10-1880	188	1880	PHG T10-1880-...
T10-630	63	630	PHG T10-630-...	T10-1960	196	1960	PHG T10-1960-...
T10-650	65	650	PHG T10-650-...	T10-1980	198	1980	PHG T10-1980-...
T10-660	66	660	PHG T10-660-...	T10-2020	202	2020	PHG T10-2020-...
T10-700	70	700	PHG T10-700-...	T10-2080	208	2080	PHG T10-2080-...
T10-720	72	720	PHG T10-720-...	T10-2090	209	2090	PHG T10-2090-...
T10-730	73	730	PHG T10-730-...	T10-2100	210	2100	PHG T10-2100-...
T10-750	75	750	PHG T10-750-...	T10-2200	220	2200	PHG T10-2200-...
T10-770	77	770	PHG T10-770-...	T10-2250	225	2250	PHG T10-2250-...
T10-780	78	780	PHG T10-780-...	T10-2270	227	2270	PHG T10-2270-...
T10-800	80	800	PHG T10-800-...	T10-2300	230	2300	PHG T10-2300-...
T10-810	81	810	PHG T10-810-...	T10-2340	234	2340	PHG T10-2340-...
T10-840	84	840	PHG T10-840-...	T10-2360	236	2360	PHG T10-2360-...
T10-850	85	850	PHG T10-850-...	T10-2380	238	2380	PHG T10-2380-...
T10-880	88	880	PHG T10-880-...	T10-2430	243	2430	PHG T10-2430-...
T10-890	89	890	PHG T10-890-...	T10-2480	248	2480	PHG T10-2480-...
T10-900	90	900	PHG T10-900-...	T10-2500	250	2500	PHG T10-2500-...
T10-910	91	910	PHG T10-910-...	T10-2540	254	2540	PHG T10-2540-...
T10-920	92	920	PHG T10-920-...	T10-2590	259	2590	PHG T10-2590-...
T10-950	95	950	PHG T10-950-...	T10-2610	261	2610	PHG T10-2610-...
T10-960	96	960	PHG T10-960-...	T10-2650	265	2650	PHG T10-2650-...
T10-970	97	970	PHG T10-970-...	T10-2800	280	2800	PHG T10-2800-...
T10-980	98	980	PHG T10-980-...	T10-2880	288	2880	PHG T10-2880-...
T10-1000	100	1000	PHG T10-1000-...	T10-3000	300	3000	PHG T10-3000-...
T10-1010	101	1010	PHG T10-1010-...	T10-3040	304	3040	PHG T10-3040-...
T10-1040	104	1040	PHG T10-1040-...	T10-3100	310	3100	PHG T10-3100-...
T10-1050	105	1050	PHG T10-1050-...	T10-3230	323	3230	PHG T10-3230-...
T10-1080	108	1080	PHG T10-1080-...	T10-3300	330	3300	PHG T10-3300-...
T10-1100	110	1100	PHG T10-1100-...	T10-3340	334	3340	PHG T10-3340-...
T10-1110	111	1110	PHG T10-1110-...	T10-3500	350	3500	PHG T10-3500-...
T10-1140	114	1140	PHG T10-1140-...	T10-3600	360	3600	PHG T10-3600-...
T10-1150	115	1150	PHG T10-1150-...	T10-3680	368	3680	PHG T10-3680-...
T10-1200	120	1200	PHG T10-1200-...	T10-3870	387	3870	PHG T10-3870-...
T10-1210	121	1210	PHG T10-1210-...	T10-4040	404	4040	PHG T10-4040-...
T10-1240	124	1240	PHG T10-1240-...	T10-4280	428	4280	PHG T10-4280-...
T10-1250	125	1250	PHG T10-1250-...	T10-4680	468	4680	PHG T10-4680-...
T10-1260	126	1260	PHG T10-1260-...	T10-5060	506	5060	PHG T10-5060-...
T10-1280	128	1280	PHG T10-1280-...	T10-5360	536	5360	PHG T10-5360-...
T10-1300	130	1300	PHG T10-1300-...	T10-5670	567	5670	PHG T10-5670-...
T10-1320	132	1320	PHG T10-1320-...	T10-6000	600	6000	PHG T10-6000-...
T10-1350	135	1350	PHG T10-1350-...	T10-6290	629	6290	PHG T10-6290-...
T10-1390	139	1390	PHG T10-1390-...	T10-7000	700	7000	PHG T10-7000-...
T10-1400	140	1400	PHG T10-1400-...	T10-7050	705	7050	PHG T10-7050-...

Úplné značení musí obsahovat šířku pásu v mm.

Nabídka obsahuje rovněž nestandardní délky.

Řemenové rukávky se dodávají v různých šířkách. Kontaktujte, prosím, Vašeho zástupce SKF.



Metrické ozubené řemeny

T20

- ▶ Řemeny
- ▶ Řetězy
- ▶ Spojky
- ▶ Pouzdra a náboje
- ▶ Řetězová kola
- ▶ Řemenice
- ▶ Inteligentní nástroje

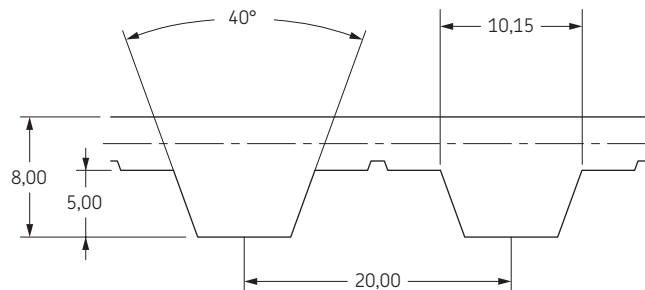

Typ řemenu	Počet zubů	Rozečtná délka		Označení
		mm		
T20-1180	59	1180		PHG T20-1180-...
T20-1220	61	1220		PHG T20-1220-...
T20-1240	62	1240		PHG T20-1240-...
T20-1260	63	1260		PHG T20-1260-...
T20-1280	64	1280		PHG T20-1280-...
T20-1460	73	1460		PHG T20-1460-...
T20-1680	94	1880		PHG T20-1680-...
T20-1700	85	1700		PHG T20-1700-...
T20-1780	89	1780		PHG T20-1780-...
T20-1880	94	1880		PHG T20-1880-...
T20-2040	102	2040		PHG T20-2040-...
T20-2200	110	2200		PHG T20-2200-...
T20-2240	112	2240		PHG T20-2240-...
T20-2600	130	2600		PHG T20-2600-...
T20-2720	136	2720		PHG T20-2720-...
T20-2740	137	2740		PHG T20-2740-...
T20-2760	138	2760		PHG T20-2760-...
T20-3100	155	3100		PHG T20-3100-...
T20-3620	181	3620		PHG T20-3620-...
T20-4760	238	4760		PHG T20-4760-...
T20-5000	250	5000		PHG T20-5000-...

Úplné značení musí obsahovat šířku pásu v mm.

Nabídka obsahuje rovněž nestandardní délky.

Řemenové rukávy se dodávají v různých šířkách. Kontaktujte, prosím, Vašeho zástupce SKF.

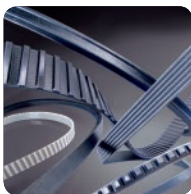

Oboustranné metrické ozubené řemeny

D-T5

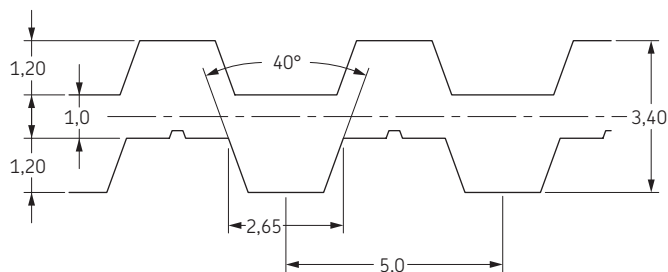
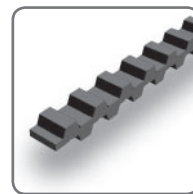

Typ řemenu	Počet zubů na jedné straně	Roztečná délka mm	Označení	Typ řemenu	Počet zubů na jedné straně	Roztečná délka mm	Označení
D...-T5-500	100	500	PHG D...-T5-500-...	D...-T5-805	161	805	PHG D...-T5-805-...
D...-T5-505	101	505	PHG D...-T5-505-...	D...-T5-810	162	810	PHG D...-T5-810-...
D...-T5-510	102	510	PHG D...-T5-510-...	D...-T5-815	163	815	PHG D...-T5-815-...
D...-T5-525	105	525	PHG D...-T5-525-...	D...-T5-840	168	840	PHG D...-T5-840-...
D...-T5-545	109	545	PHG D...-T5-545-...	D...-T5-850	170	850	PHG D...-T5-850-...
D...-T5-550	110	550	PHG D...-T5-550-...	D...-T5-860	172	860	PHG D...-T5-860-...
D...-T5-560	112	560	PHG D...-T5-560-...	D...-T5-900	180	900	PHG D...-T5-900-...
D...-T5-570	114	570	PHG D...-T5-570-...	D...-T5-940	188	940	PHG D...-T5-940-...
D...-T5-575	115	575	PHG D...-T5-575-...	D...-T5-990	198	990	PHG D...-T5-990-...
D...-T5-600	120	600	PHG D...-T5-600-...	D...-T5-995	199	995	PHG D...-T5-995-...
D...-T5-610	122	610	PHG D...-T5-610-...	D...-T5-1000	200	1000	PHG D...-T5-1000-...
D...-T5-620	124	620	PHG D...-T5-620-...	D...-T5-1020	204	1020	PHG D...-T5-1020-...
D...-T5-630	126	630	PHG D...-T5-630-...	D...-T5-1030	206	1030	PHG D...-T5-1030-...
D...-T5-635	127	635	PHG D...-T5-635-...	D...-T5-1045	209	1045	PHG D...-T5-1045-...
D...-T5-650	130	650	PHG D...-T5-650-...	D...-T5-1050	210	1050	PHG D...-T5-1050-...
D...-T5-665	133	665	PHG D...-T5-665-...	D...-T5-1060	212	1060	PHG D...-T5-1060-...
D...-T5-675	135	675	PHG D...-T5-675-...	D...-T5-1075	215	1075	PHG D...-T5-1075-...
D...-T5-685	137	685	PHG D...-T5-685-...	D...-T5-1100	220	1100	PHG D...-T5-1100-...
D...-T5-690	138	690	PHG D...-T5-690-...	D...-T5-1120	224	1120	PHG D...-T5-1120-...
D...-T5-700	140	700	PHG D...-T5-700-...	D...-T5-1140	228	1140	PHG D...-T5-1140-...
D...-T5-710	142	710	PHG D...-T5-710-...	D...-T5-1200	240	1200	PHG D...-T5-1200-...
D...-T5-720	144	720	PHG D...-T5-720-...	D...-T5-1215	243	1215	PHG D...-T5-1215-...
D...-T5-725	145	725	PHG D...-T5-725-...	D...-T5-1260	252	1260	PHG D...-T5-1260-...
D...-T5-740	148	740	PHG D...-T5-740-...	D...-T5-1300	260	1300	PHG D...-T5-1300-...
D...-T5-750	150	750	PHG D...-T5-750-...	D...-T5-1380	276	1380	PHG D...-T5-1380-...
D...-T5-780	156	780	PHG D...-T5-780-...	D...-T5-1390	278	1390	PHG D...-T5-1390-...
D...-T5-800	160	800	PHG D...-T5-800-...	D...-T5-1415	283	1415	PHG D...-T5-1415-...

Úplné značení musí obsahovat šířku pásu v mm.

Nabídka obsahuje rovněž nestandardní délky.

Oboustranné metrické ozubené řemeny jsou dodávány v symetrickém (DA) a asymetrickém (DB) provedení.

Pokud není uvedené jinak, jsou řemeny dodávány v symetrickém (DA) provedení.

Řemenové rukávy se dodávají v různých šířkách. Kontaktujte, prosím, Vašeho zástupce SKF.

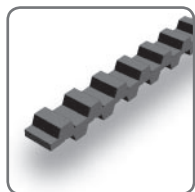

Oboustranné metrické ozubené řemeny

D-T10

- ▶ Řemeny
- ▶ Řetězy
- ▶ Spojky
- ▶ Pouzdra a náboje
- ▶ Řetězová kola
- ▶ Řemenice
- ▶ Inteligentní nástroje

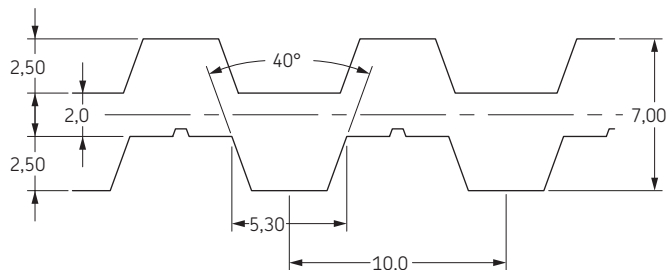

Typ řemenu	Počet zubů na jedné straně	Roztečná délka	Označení	Typ řemenu	Počet zubů na jedné straně	Roztečná délka	Označení
		mm				mm	
D...-T10-900	90	900	PHG D...-T10-900-...	D...-T10-1560	156	1560	PHG D...-T10-1560-...
D...-T10-910	91	910	PHG D...-T10-910-...	D...-T10-1600	160	1600	PHG D...-T10-1600-...
D...-T10-920	92	920	PHG D...-T10-920-...	D...-T10-1610	161	1610	PHG D...-T10-1610-...
D...-T10-950	95	950	PHG D...-T10-950-...	D...-T10-1640	164	1640	PHG D...-T10-1640-...
D...-T10-960	96	960	PHG D...-T10-960-...	D...-T10-1690	169	1690	PHG D...-T10-1690-...
D...-T10-970	97	970	PHG D...-T10-970-...	D...-T10-1700	170	1700	PHG D...-T10-1700-...
D...-T10-980	98	980	PHG D...-T10-980-...	D...-T10-1750	175	1750	PHG D...-T10-1750-...
D...-T10-1000	100	1000	PHG D...-T10-1000-...	D...-T10-1780	178	1780	PHG D...-T10-1780-...
D...-T10-1010	101	1010	PHG D...-T10-1010-...	D...-T10-1800	180	1800	PHG D...-T10-1800-...
D...-T10-1040	104	1040	PHG D...-T10-1040-...	D...-T10-1860	186	1860	PHG D...-T10-1860-...
D...-T10-1050	105	1050	PHG D...-T10-1050-...	D...-T10-1880	188	1880	PHG D...-T10-1880-...
D...-T10-1080	108	1080	PHG D...-T10-1080-...	D...-T10-1960	196	1960	PHG D...-T10-1960-...
D...-T10-1100	110	1100	PHG D...-T10-1100-...	D...-T10-1980	198	1980	PHG D...-T10-1980-...
D...-T10-1110	111	1110	PHG D...-T10-1110-...	D...-T10-2020	202	2020	PHG D...-T10-2020-...
D...-T10-1140	114	1140	PHG D...-T10-1140-...	D...-T10-2080	208	2080	PHG D...-T10-2080-...
D...-T10-1150	115	1150	PHG D...-T10-1150-...	D...-T10-2090	209	2090	PHG D...-T10-2090-...
D...-T10-1200	120	1200	PHG D...-T10-1200-...	D...-T10-2100	210	2100	PHG D...-T10-2100-...
D...-T10-1210	121	1210	PHG D...-T10-1210-...	D...-T10-2200	220	2200	PHG D...-T10-2200-...
D...-T10-1240	124	1240	PHG D...-T10-1240-...	D...-T10-2250	225	2250	PHG D...-T10-2250-...
D...-T10-1250	125	1250	PHG D...-T10-1250-...	D...-T10-2270	227	2270	PHG D...-T10-2270-...
D...-T10-1260	126	1260	PHG D...-T10-1260-...	D...-T10-2300	230	2300	PHG D...-T10-2300-...
D...-T10-1280	128	1280	PHG D...-T10-1280-...	D...-T10-2340	234	2340	PHG D...-T10-2340-...
D...-T10-1300	130	1300	PHG D...-T10-1300-...	D...-T10-2360	236	2360	PHG D...-T10-2360-...
D...-T10-1320	132	1320	PHG D...-T10-1320-...	D...-T10-2380	238	2380	PHG D...-T10-2380-...
D...-T10-1350	135	1350	PHG D...-T10-1350-...	D...-T10-2430	243	2430	PHG D...-T10-2430-...
D...-T10-1390	139	1390	PHG D...-T10-1390-...	D...-T10-2480	248	2480	PHG D...-T10-2480-...
D...-T10-1400	140	1400	PHG D...-T10-1400-...	D...-T10-2500	250	2500	PHG D...-T10-2500-...
D...-T10-1420	142	1420	PHG D...-T10-1420-...	D...-T10-2540	254	2540	PHG D...-T10-2540-...
D...-T10-1440	144	1440	PHG D...-T10-1440-...	D...-T10-2590	259	2590	PHG D...-T10-2590-...
D...-T10-1450	145	1450	PHG D...-T10-1450-...	D...-T10-2610	261	2610	PHG D...-T10-2610-...
D...-T10-1460	146	1460	PHG D...-T10-1460-...	D...-T10-2650	265	2650	PHG D...-T10-2650-...
D...-T10-1480	148	1480	PHG D...-T10-1480-...	D...-T10-2800	280	2800	PHG D...-T10-2800-...
D...-T10-1500	150	1500	PHG D...-T10-1500-...	D...-T10-2880	288	2880	PHG D...-T10-2880-...
D...-T10-1520	152	1520	PHG D...-T10-1520-...	D...-T10-3000	300	3000	PHG D...-T10-3000-...

Úplné značení musí obsahovat šířku pásu v mm.

Nabídka obsahuje rovněž nestandardní délky.

Oboustranné metrické ozubené řemeny jsou dodávány v symetrickém (DA) a asymetrickém (DB) provedení. Pokud není uvedené jinak, jsou řemeny dodávány v symetrickém (DA) provedení.

Řemenové rukávy se dodávají v různých šířkách. Kontaktujte, prosím, Vašeho zástupce SKF.

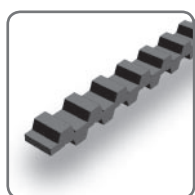

Oboustranné metrické ozubené řemeny

D-T20

Typ řemenu	Počet zubů na jedné straně	Roztečná délka	Označení
		mm	
D...-T20-1700	85	1700	PHG D...-T20-1700-...
D...-T20-1780	89	1780	PHG D...-T20-1780-...
D...-T20-1880	94	1880	PHG D...-T20-1880-...
D...-T20-2040	102	2040	PHG D...-T20-2040-...
D...-T20-2200	110	2200	PHG D...-T20-2200-...
D...-T20-2240	112	2240	PHG D...-T20-2240-...
D...-T20-2600	130	2600	PHG D...-T20-2600-...
D...-T20-2720	136	2720	PHG D...-T20-2720-...
D...-T20-2740	137	2740	PHG D...-T20-2740-...
D...-T20-2760	138	2760	PHG D...-T20-2760-...
D...-T20-3100	155	3100	PHG D...-T20-3100-...
D...-T20-3620	181	3620	PHG D...-T20-3620-...
D...-T20-4760	238	4760	PHG D...-T20-4760-...
D...-T20-5000	250	5000	PHG D...-T20-5000-...

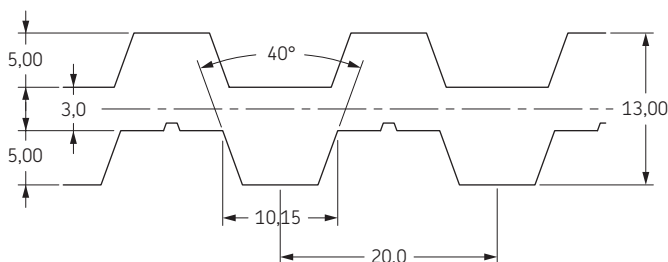

Úplné značení musí obsahovat šířku pásu v mm.

Nabídka obsahuje rovněž nestandardní délky.

Oboustranné metrické ozubené řemeny jsou dodávány v symetrickém (DA) a asymetrickém (DB) provedení.

Pokud není uvedené jinak, jsou řemeny dodávány v symetrickém (DA) provedení.

Řemenové rukávy se dodávají v různých šířkách. Kontaktujte, prosím, Vašeho zástupce SKF.